

Power and Performance

for the Automotive Industry Vol. III



You'll find many Tsubaki products being

There are many processes involved in making a motor vehicle. You'll find Tsubaki products in all of these processes, from conveying vehicle bodies from the stockyard, components from the formation presses, and assembled bodies from the welding process to the painting process, to the mounting and assembly processes for the interior, engine, transmission, and other components, and finally to engine output, brakes, and shower testing lines.

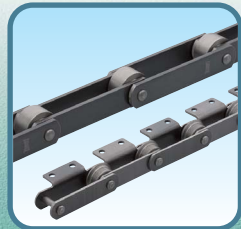

Large Size Conveyor Chain



Zip Chain Lifter[®]

Automotive parts

Press part conveyance at supplier facilities

1 Press Shop

Cutting, casting, forging, sheet metal presses, plastic molding, etc

5 Inspection Line

Engine output, brakes, shower tester, visual inspection



Bearing Roller Conveyor Chain

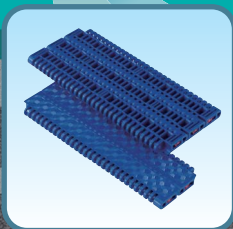

Plastic Modular Chain

4 Assembly Shop

Mounting of interior components (engine, suspension, transmission, dashboard, seats, electrical components) and exterior components (tires, fenders, side view mirrors, etc.)

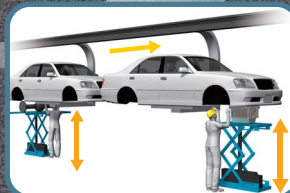

Zip Chain Lifter[®]



Lift Master

Automotive parts

Manufacture/assembly of various automotive parts



Double Plus Chain



Timing Chain

used in automotive manufacturing

2

Body Welding Shop

Welding and assembly of roofs and body panels



Lift Master



ROBOTRAX System Cable Carrier



Zip Chain Actuator®

3

Paint Shop

Coating of bodies, doors, and other components

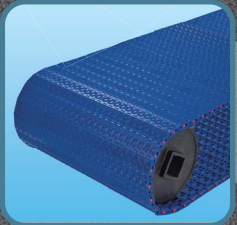

Plastic Modular Chain



Symtrack™



ROBOTRAX System Cable Carrier



Strong (relatively high-strength product)



Compact



Easy installation



Low maintenance



High-speed

1 Press Shop

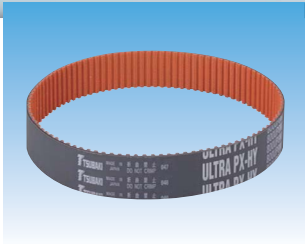

For servo press operation HY Type Ultra PX Belt



The belts used on servo presses—machines that are run continuously and frequently subjected to shock loading—are required to be both highly strong and rigid. That's why customers choose Tsubaki's HY Type belt, which is approximately twice as strong and rigid as the HC Type Ultra PX Belt. This belt enables drive sections to be downsized and made more compact.

The HY features "ultra" high strength.

Achieving transmission capacity enhanced to a level approximately 1.3X to 2.0X that of our HC Type!

Ultra-high strength

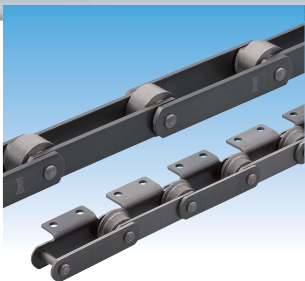
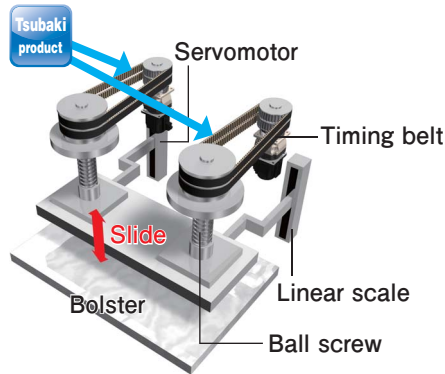
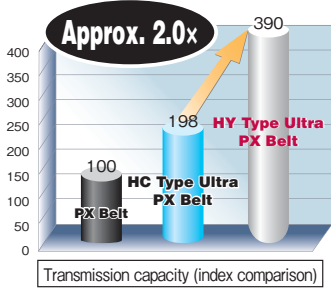

For scrap conveyors Large Size Conveyor Chain



Multiple scrap conveyors operate to remove scrap from the press plant floor. Following press processes, scrap is transported away from the plant using a scrap conveyor in which slats have been installed to Tsubaki's large size conveyor chains.

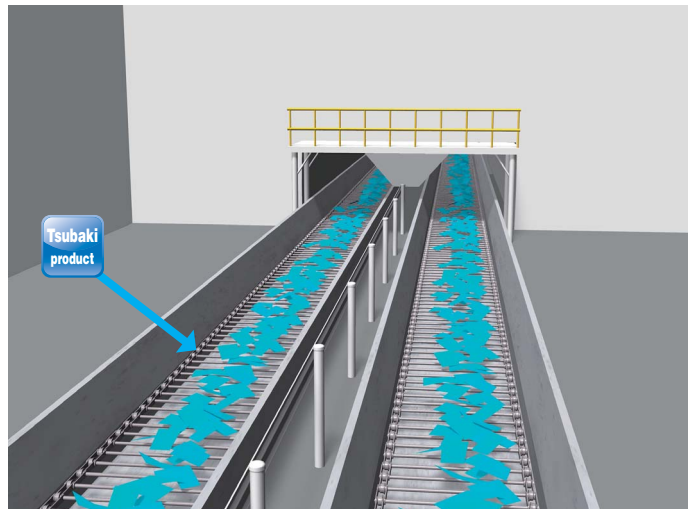
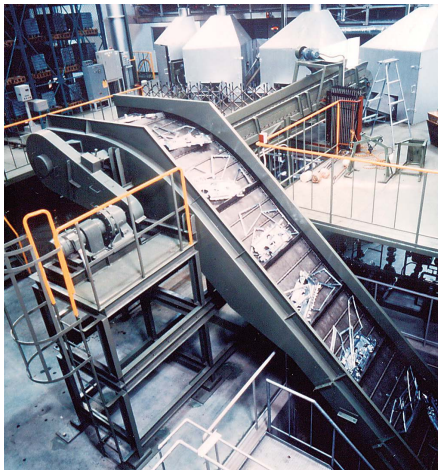



For lifting parts Zip Chain Lifter®

The Zip Chain Lifter shown here is used to raise or lower stacked materials for pressing or parts that have already been pressed. This Zip Chain Lifter can be raised and lowered more quickly than hydraulic lifters and contributes to enhanced productivity thanks to its high level of positioning accuracy.

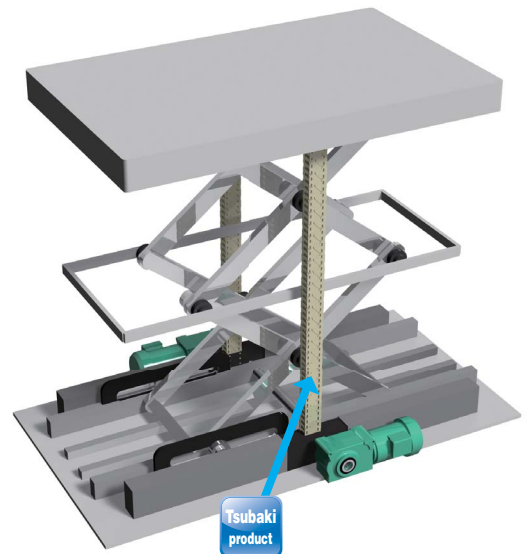

For actuating traverse movement of spray nozzles Zip Chain Actuator®

Tsubaki's Zip Chain Actuators are employed to realize the traverse movement of nozzles used to spray metalworking fluids during press processes. These actuators can be used to achieve compact and high-speed traverse motion even in narrow spaces.

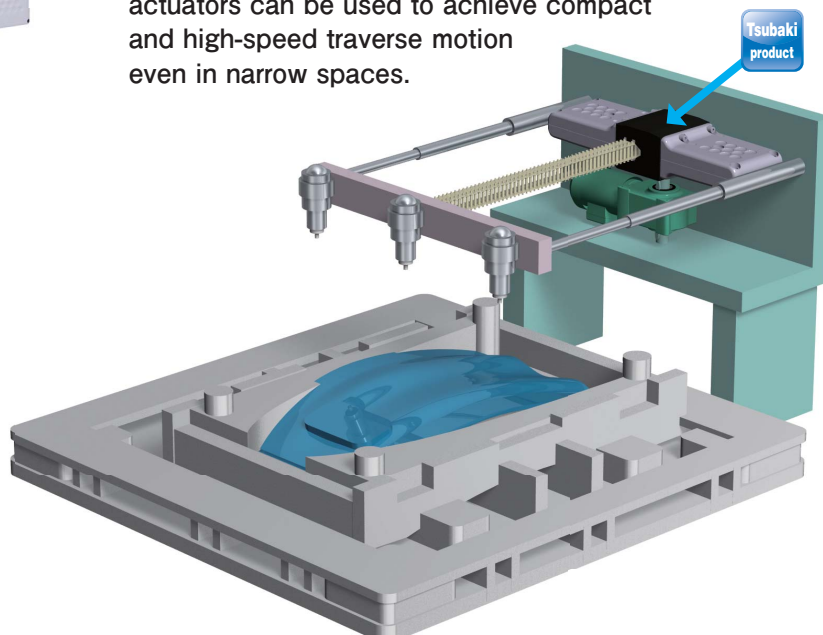

2 Body Welding Shop

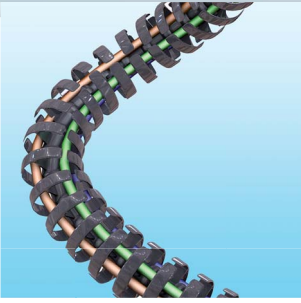

For body assembly equipment ROBOTRAX System Cable Carrier

The Tsubaki ROBOTRAX System features 3D movement capabilities and is employed in robot arms used for body welding processes. Not only does the ROBOTRAX System make use of engineering plastics to achieve superior levels of product protection and durability, it also features embedded steel wiring for boosted tensile strength. The open structure of the cable carrier permits cables to be pushed in and inserted, while also facilitating maintenance. Our cable carriers are also used to protect hoses employed in transporting water used to prevent welding robots from catching on fire.

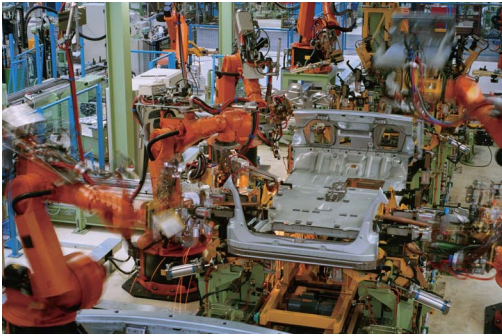
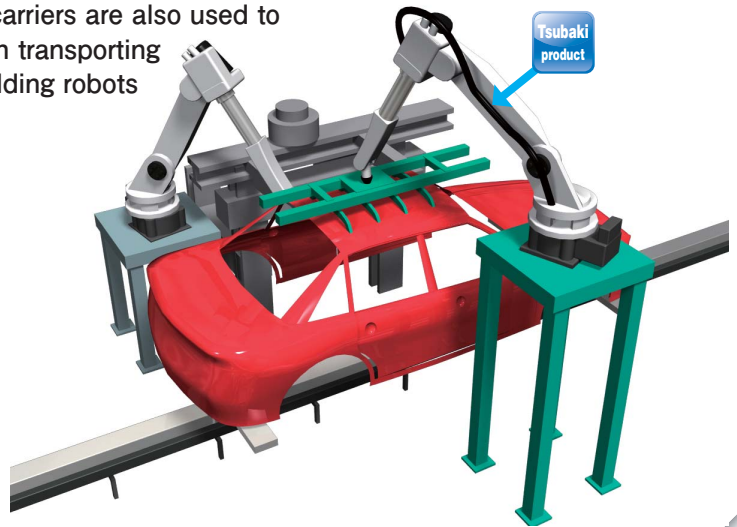

For lifting automotive body loading pallets Lift Master

Our Lift Master series—in which two machines can be linked and operated on one side—is used on equipment for raising and lowering the pallets that load automotive bodies into the welding process. Synchronizing operation of two Lift Master models—which are electric lifters with a simple structure—is possible by mechanically linking the two, or by installing a motor to each side. Either way, the Lift Master enables customers to achieve a streamlined and clean work space.

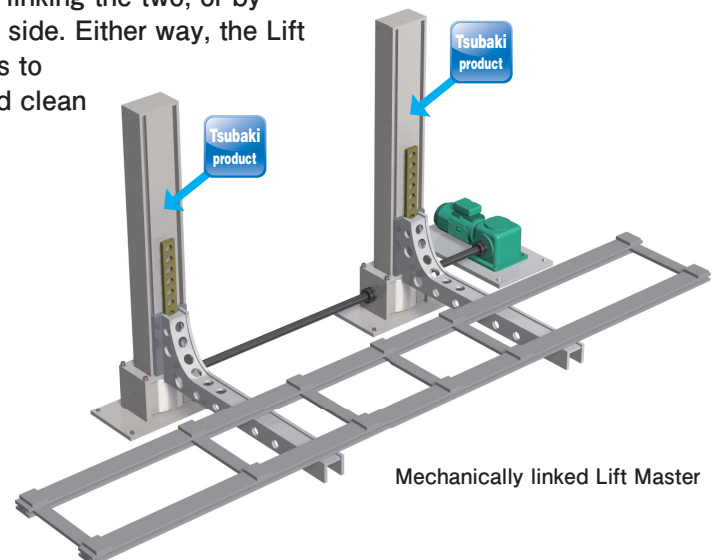



For body assembly equipment Lift Master

Our Lift Master series is used in equipment that lowers empty pallets to the return conveyor located below after parts that had been loaded on the pallets, such as rear doors, have been removed. Raising and lowering from just one side is possible, meaning installation can be made in narrow spaces, resulting in enhanced space utilization.

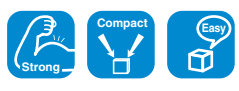

Tsubaki product

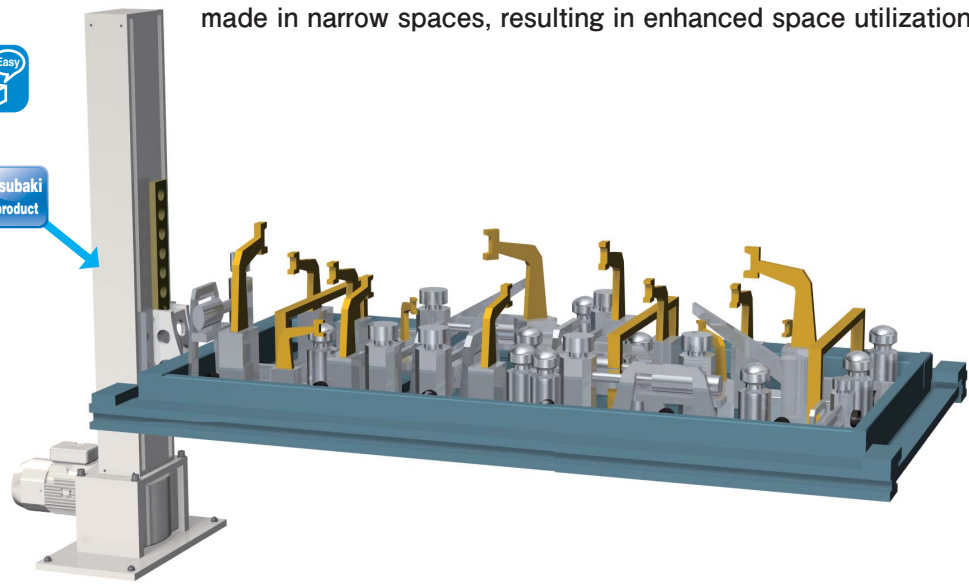

For body assembly equipment Lift Master

Our Lift Master series—with its lateral load strength and long service life—is used on equipment for transferring assembled automotive bodies to trolleys bound for the next manufacturing process.

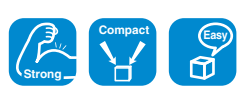

Tsubaki product

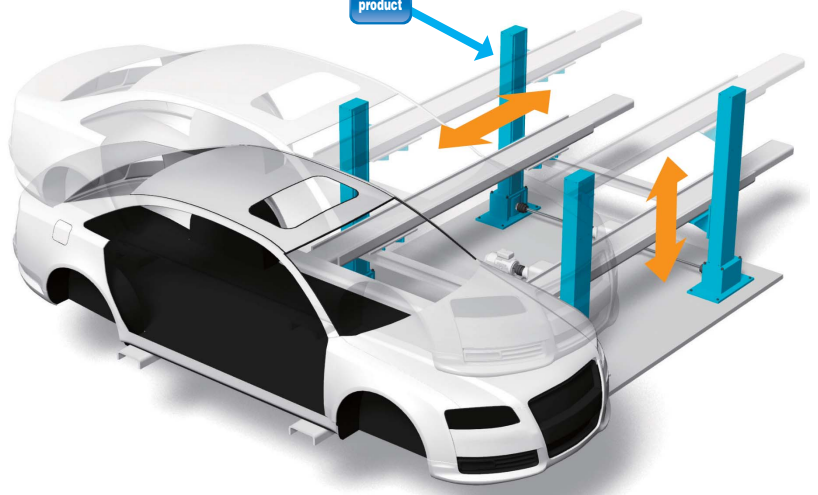

2 Body Welding Shop



For part unloading equipment Zip Chain Actuator®

Our compact Zip Chain Actuator is used in the lifting part of simple loading equipment. It enables the manufacture of equipment with simple mechanisms and enhanced part pick-up speeds.

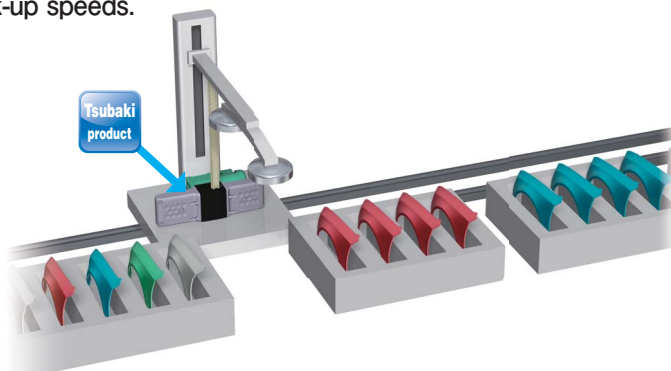

For part gantry loaders Zip Chain Actuator®

Our Zip Chain Actuators—capable of being installed in narrow spaces—are used in the elevating mechanisms of gantry loaders employed in factory conveyance systems. Because a pneumatic cylinder isn't used for raising and lowering, there's no concern about a cylinder protruding out to the ceiling side, enabling use with lower ceilings.

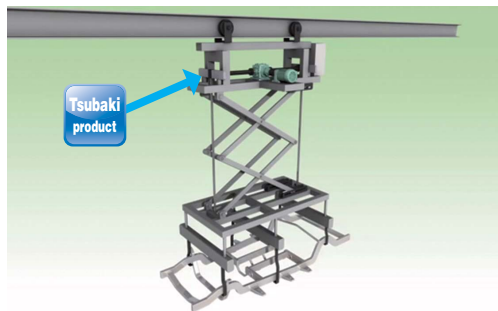

For side panel welding jigs Zip Chain Actuator®

When used in welding shop in which parts of different sizes are manufactured, the position of support pillars must be changed to suit the part currently being manufactured. Tsubaki's Zip Chain Actuators are used to actuate the up and down movement of these support pillars. Also, its collapsed height has resulted in a low-profile and compact guide.

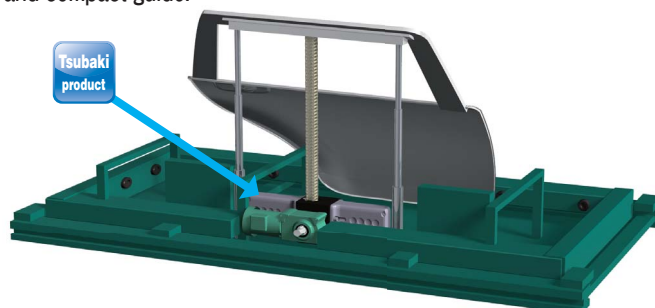

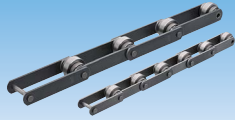

For pallet conveyance Double Plus Chain/Steel Roller Series



Our Double Plus Chain/Steel Roller Series—capable of accumulation—is used for the conveyance of body transport pallets. Thin frames can also be used to create a compact conveyor system.



For welding robots Cable Carriers Plastic Series



Our Cable Carriers Plastic Series is used for protecting the cables of welding robots as they traverse. The TKC and TKMT Series (MT series) of our Long-Span Specification Glide Shoe series work to minimize cable carrier wear and extend product service life in factory robots that traverse in long strokes.



Long-Span Specification/Glide Shoe Series

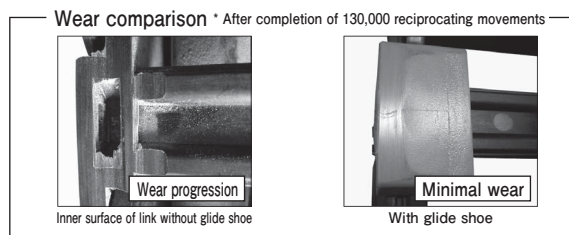

For welding electrode movement HC Type Ultra PX Belt



A clean and compact transmission mechanism—one high in strength and accuracy, but also free from grease or oil spatter—is required for applications in which guns are used to move welding electrodes. That's why customers select our HC Type Ultra PX Belt.

High accuracy

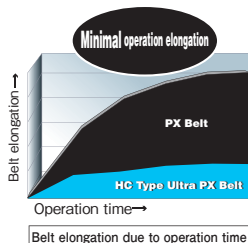

High strength

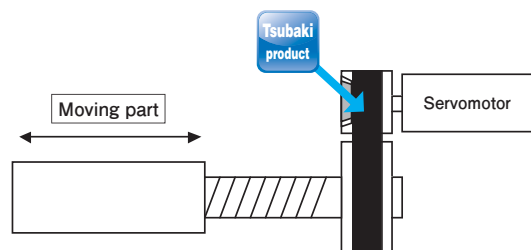
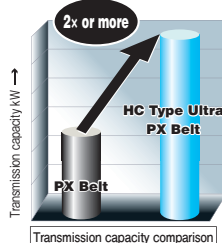

3 Paint Shop

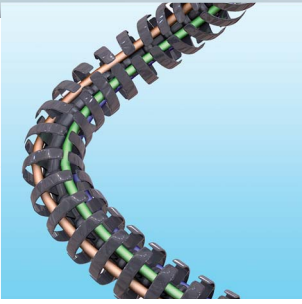

For painting robots ROBOTRAX System Cable Carrier

To smoothen the surface and prevent colors from fading during paint processes, spraying of gray paint is performed by painting robots with perfect consistency. The ROBOTRAX System from Tsubaki's Cable Carrier Plastic Series features 3D movement capabilities, as well as a wire core designed to support the electrical wires of multi-axis robots.

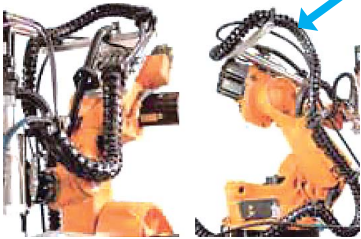

Tsubaki
product

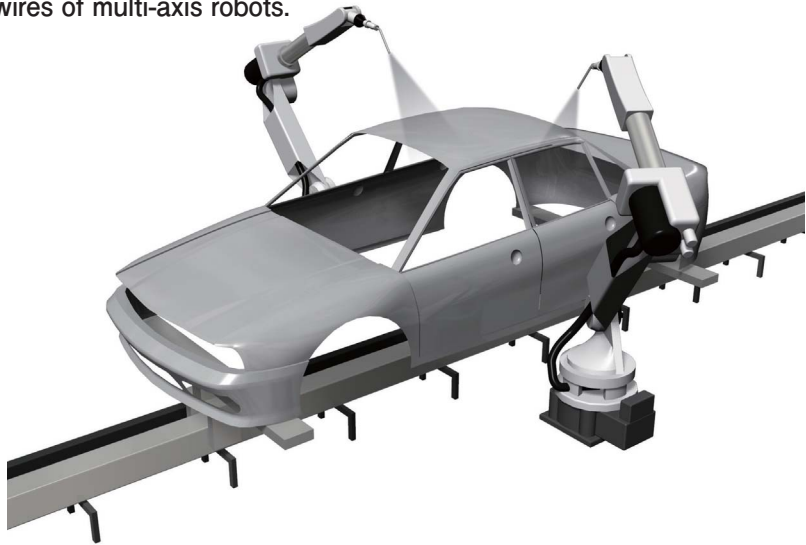



Automotive body transport system Symtrack™

During paint processes, automotive bodies are loaded onto trolleys for conveyance. Because such conveyance systems are required to be simple, compact and feature an easy installation, this particular design made use of Tsubaki's Symtrack friction conveyance system, which enables wiring to be laid out within the rails.

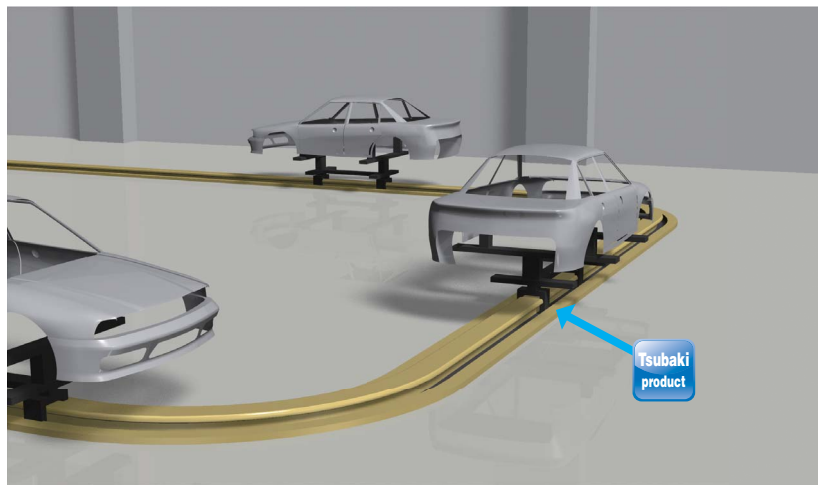
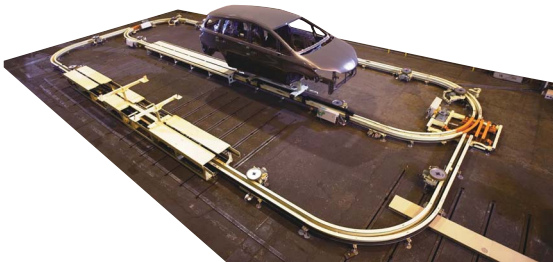

For lifting automotive bodies Zip Chain Lifter®, Zip Master

Our Zip Chain Lifter and Zip Master products are used for high-speed lifting of automotive bodies during assembly processes, or for transferring painted automotive bodies to overhead conveyors. They can also be used to boost productivity when used in lifting applications thanks to their ability to handle high loads even at high lifting heights.



Zip Chain Lifter®

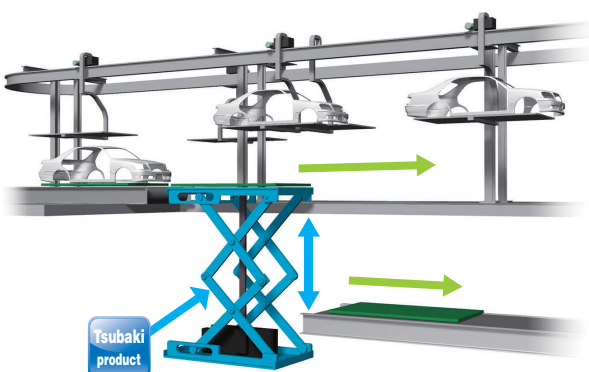

Zip Master

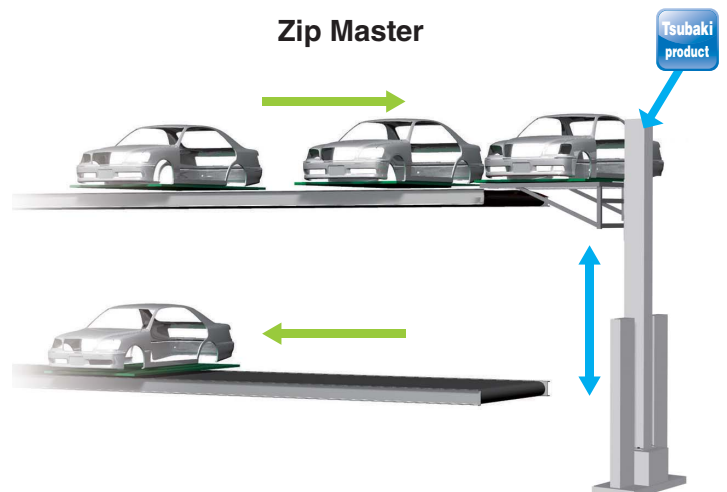

4 Assembly Shop



For automotive conveyance Bearing Roller Conveyor Chain

Our Bearing Roller Conveyor Chain features a unique structure in which cylindrical bearings have been placed inside rollers. The rollers create minimal amounts of rolling resistance, lowering both chain tension and required power levels, resulting in decreased power consumption. It also features a design that prevents vibrations when movement is slow.

Reduced chain running resistance

Fewer roller rotation defects and reduced rail wear

The cylindrical bearings help smoothen roller rotation and reduce rail wear. They also work to significantly enhance roller wear life.

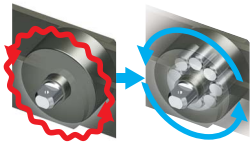

Chain running resistance

Approx. $\frac{1}{3}$

Better wear life

Reduced chain tension/required power levels

Because chain tension and required power levels are cut to approx. 1/3rd, the chain itself can be made smaller, enabling the overall conveyor to be made more compact. This has the effect of increasing energy savings and significantly reducing costs by decreasing power consumption levels.

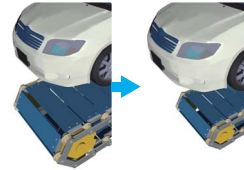

Wear life of **3x or more**

* Models with waterproof specifications feature 2x the wear life of RT models

Stable conveyance

Prevents vibrations during low-speed movement

This design prevents vibrations by conveying items in a stable manner that not only reduces worker motion sickness on assembly lines, but also greatly enhances productivity.



Significantly increased productivity

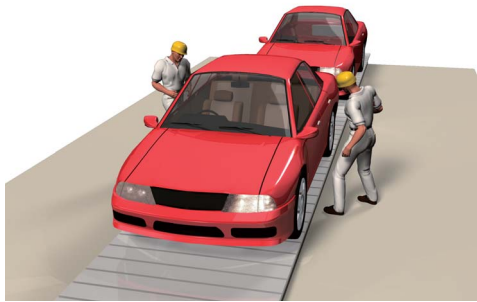

For automotive body transfer Lift Master

In the assembly process, conveyance is performed with automotive bodies being transferred between processes. In this case, two of Tsubaki's "plug-and-play" type Lift Master models are used. When lifting, the Lift Master itself traverses along the production line—shortening loading times, as well as the takt time for the overall process.

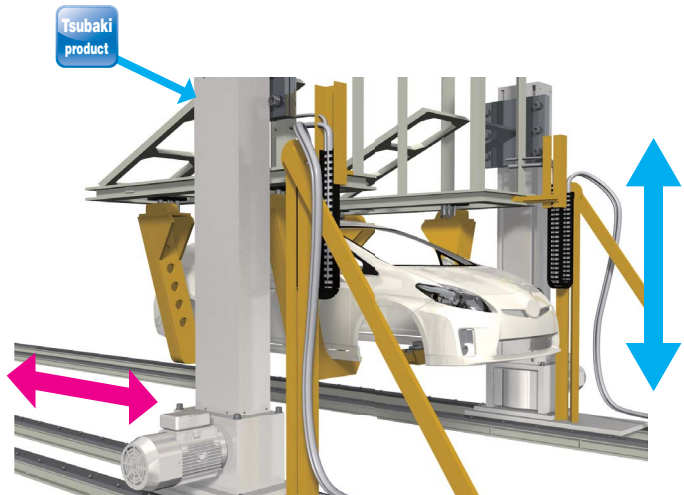
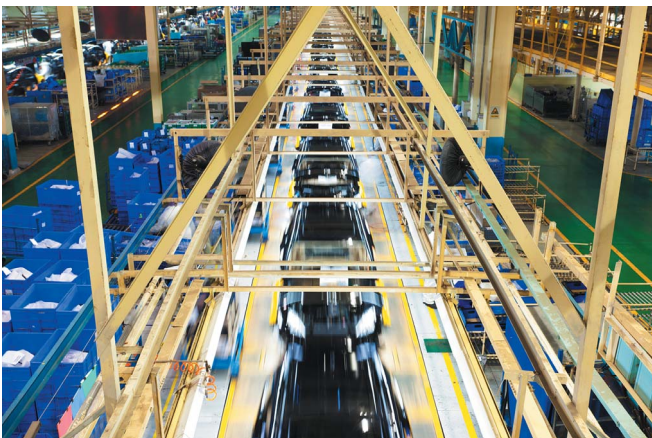



For installing engines and rear suspensions Zip Chain Lifter®

Sometimes, equipment is used to mount engines and rear suspensions to automotive bodies suspended by an overhead conveyor. This is a process that requires a high level of positioning accuracy. In this case, our Zip Chain Lifter is used, which features better stopping accuracy than hydraulic lifters and which is also capable of high-speed lifting.

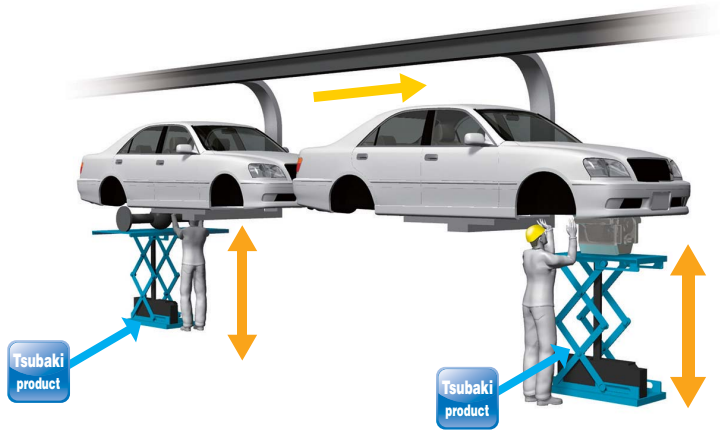
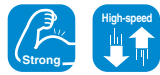

For lifting automotive parts Zip Chain Lifter®

To more effectively utilize factory space, seats and doors may need to be supplied from above the process line and separated from the automotive body conveyor. In this case, Tsubaki's Zip Chain Lifter is used to enable smooth, yet high-speed lifting in a process where parts are lowered to the vehicle from above.

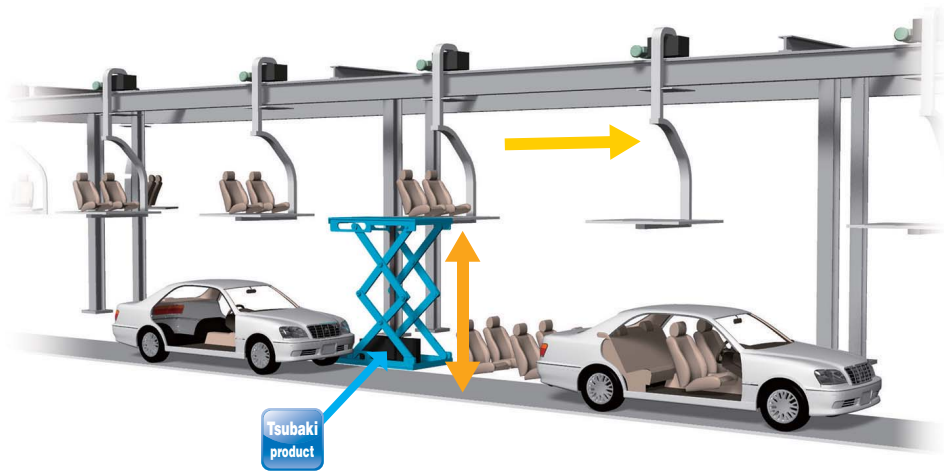
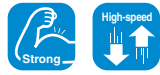

4 Assembly Shop

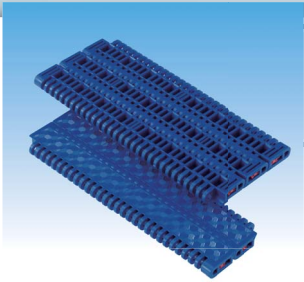

For conveyors Plastic Modular Chain

Conveyors that convey workers and tool trolleys along with the vehicle are installed for the purpose of enhancing work efficiency in processes where parts are assembled to vehicles. This particular conveyor is our clean Plastic Modular Chain that does not require lubrication. Sections are easy to connect and reattach, facilitating maintenance.

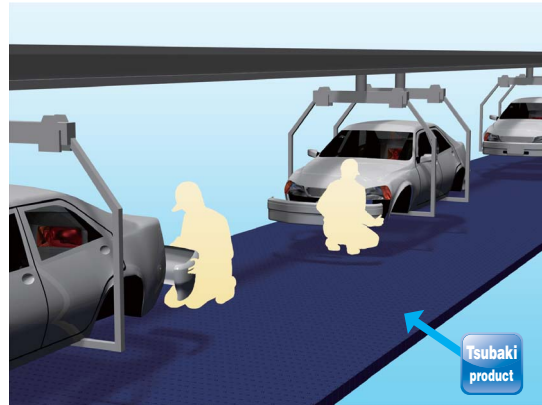
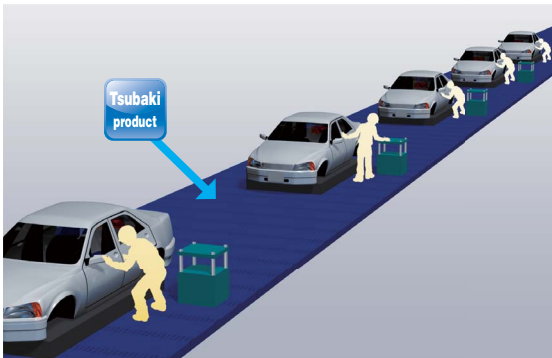

■ Recommended conveyor installation shop



Assembly to automotive body

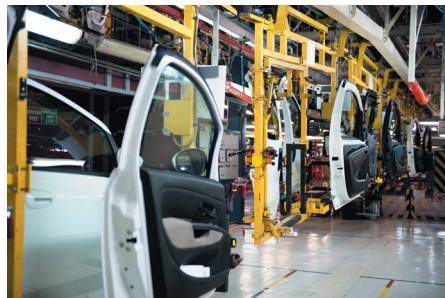

Door assembly shop

For low-profile conveyors Plastic Modular Chain WT3109-W Series

This Plastic Modular Chain in particular is designed for low-profile conveyors that move workers or tool trolleys. With this, the installation height of the conveyor can be lowered (max. 220 mm) without the need to create a pit space.

With a surface shape designed to eliminate slips

Protrusions on a floor surface can cause tool trolleys to vibrate when moving, possibly causing tools to fall. By giving the top surface of the chain a special shape, vibrations to both wheels and the trolley can be prevented, as can worker slips.

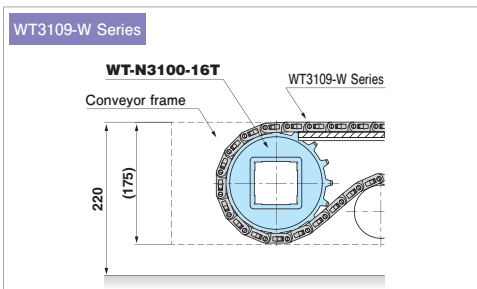
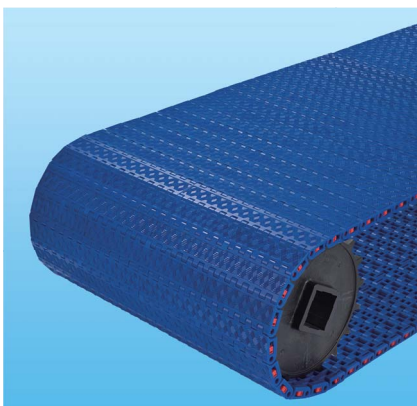

Recommended conditions

Chain width 1200 mm or less
Machine length 30 m or less
Conveyed weight 100 kg/m or less





For pallet conveyance Double Plus Chain/Steel Roller Series

Accumulation is often employed in equipment used to load parts such as seats onto pallets and supply them to the assembly line, which is where our Double Plus Chain/Steel Roller Series is used. Because pallets loaded with heavy objects can also be transported, damage to pallets themselves can be minimized. We propose use of our Engineering Plastic Roller series for pallet conveyors where accumulation is often employed for lightweight objects.

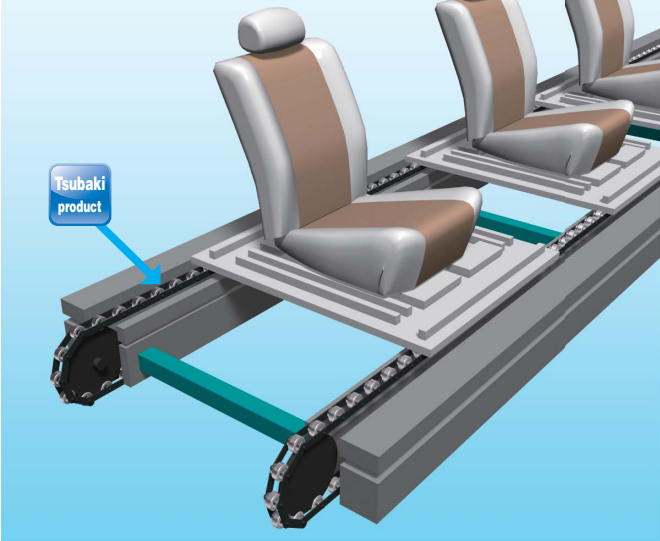

For transferring automotive parts Lift Master, Pin Gear Drive Units

A module that includes our Lift Master and Pin Gear Drive Units is used in equipment that rotates heavy items such as rear suspensions as it transfers them between conveyors. By installing the “plug-and-play” capable Lift Master to a rotating plate that utilizes our Pin Gear Drive Units, rotations and transfers can be performed smoothly—even in a compact space.

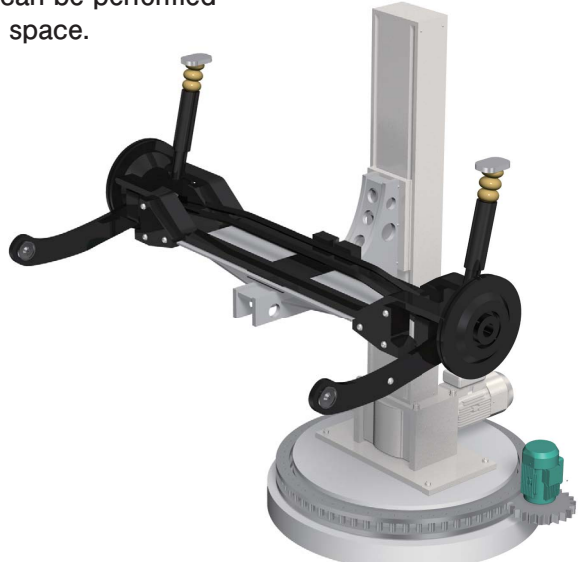



For automotive body assembly Lift Master

By lifting the automotive body using two Lift Masters—on both the left and right sides—work space can be secured while the need to change out equipment due to product model changes can be minimized.



Strong specification
When vibrations during lifting or slackening when stopped are a problem, we can provide a specification that reinforces the pillars themselves. Contact us for details.

Tsubaki
product

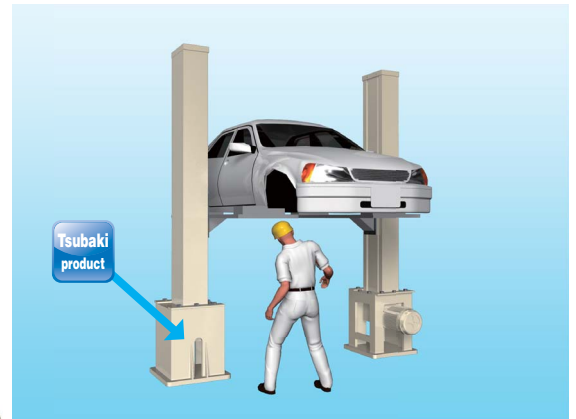
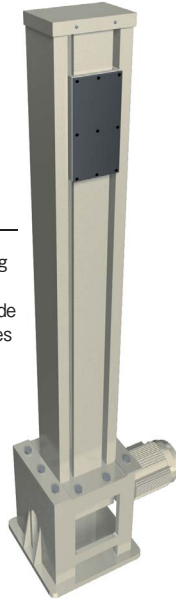

For tire mounting Lift Master

Shown here is equipment to which numerous tires are loaded. Before being conveyed to the assembly line, it separates the tires individually or places them onto different levels. In the case of this equipment, two Lift Masters are being used to lift tires.

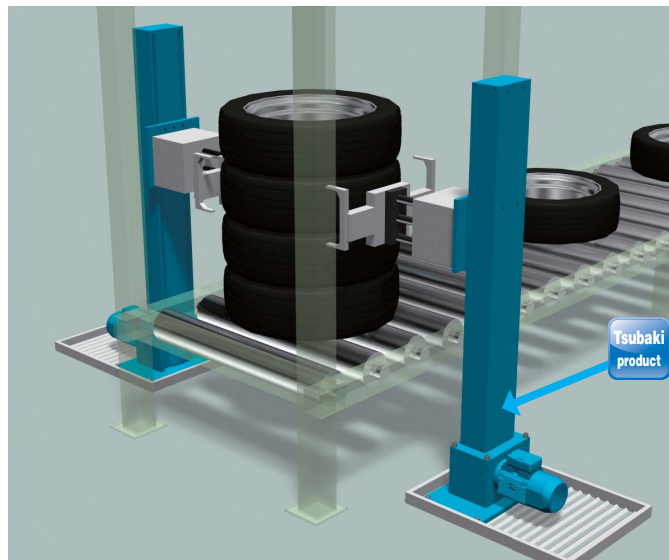



For securing trolleys Power Cylinder

Our Power Cylinders are used to secure trolleys to which vehicles are loaded. It works to minimize energy consumption and can be installed in the limited space available for trolleys.

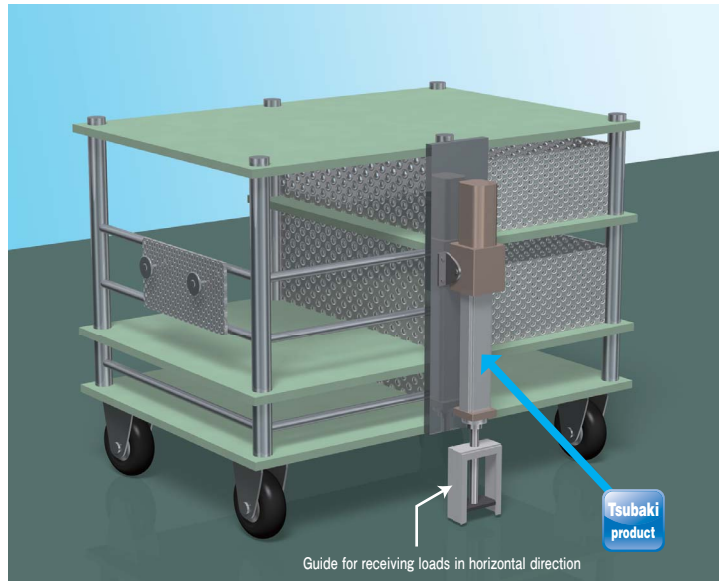

For receiving and lifting interior parts Zip Master

Interior parts such as seats are loaded onto pallets and delivered to the assembly plant. Tsubaki's Zip Master—with its high-speed, high-frequency and high-accuracy lifting capabilities—is used in equipment designed for multi-stage positioning of the roller conveyors used to deliver these parts to the assembly line. Because this equipment is "plug-and-play," it can be installed in a short time period, enabling factory improvements to be made quickly.

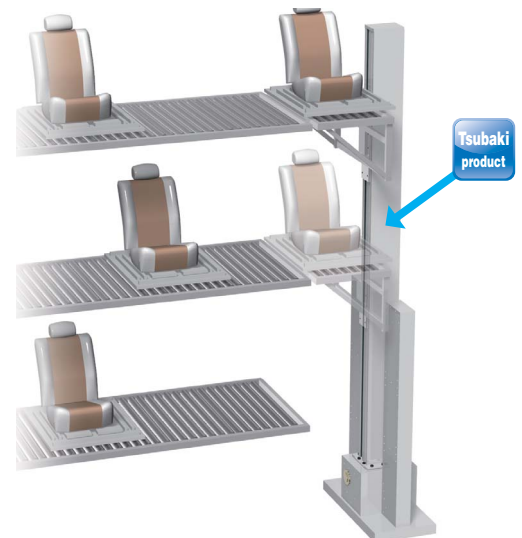

5 Inspection Line

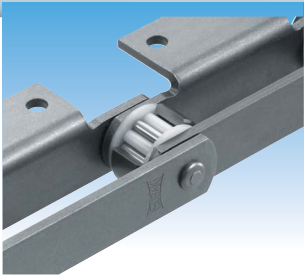

For slat conveyors Bearing Roller Conveyor Chain Lube-Free Series Water Resistant Specification



After undergoing engine, brake and light axis testing, completed vehicles pass through a booth where they are power washed for the purpose of shower testing. In this process, completed vehicles are loaded and transported using a long conveyor chain that moves at slow speeds. This long, low-speed conveyor is constantly sprayed with water and can be subject to vibrations. This is where Tsubaki's Bearing Roller Conveyor Chain Lube-free Series Water Resistant Specification really shows its stuff. The rollers of this chain feature cylindrical bearings—a Tsubaki-original structure designed to minimize vibration while enhancing efficiency, reducing costs, and extending the service life of rollers and rails.

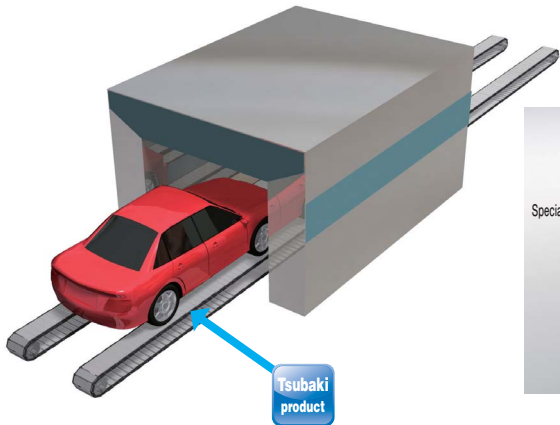

Structure

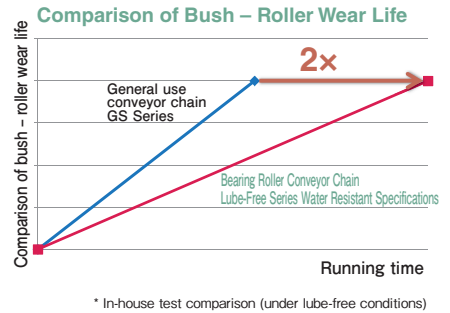
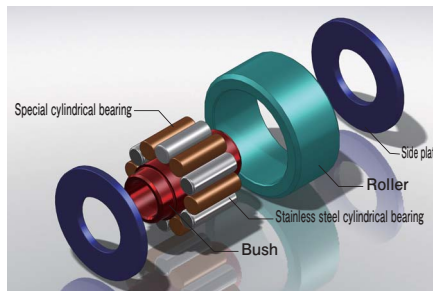

For low-profile slat conveyors Short-Pitch, Large Size Conveyor Chain With Outboard Rollers

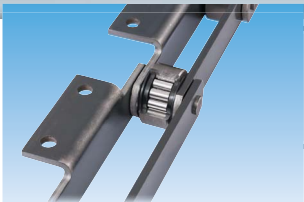

In this assembly process, conveyance of vehicles is performed on a slat conveyor in which slats have been installed to a conveyor chain. With normal conveyor chains, installation would require digging of pit. However, by shortening the chain pitch, the conveyor itself can be given a lower profile, permitting it to be installed on the floor surface without a pit needing to be dug and in turn shortening the overall installation period. The outboard rollers used here feature embedded bearings that enhance roller allowable load while minimizing conveyor vibrations thanks to a lowered low coefficient of friction.

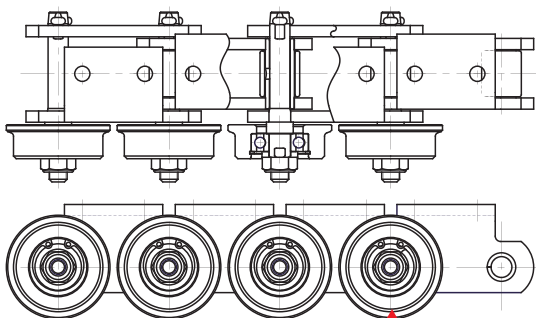

Outboard roller with bearing

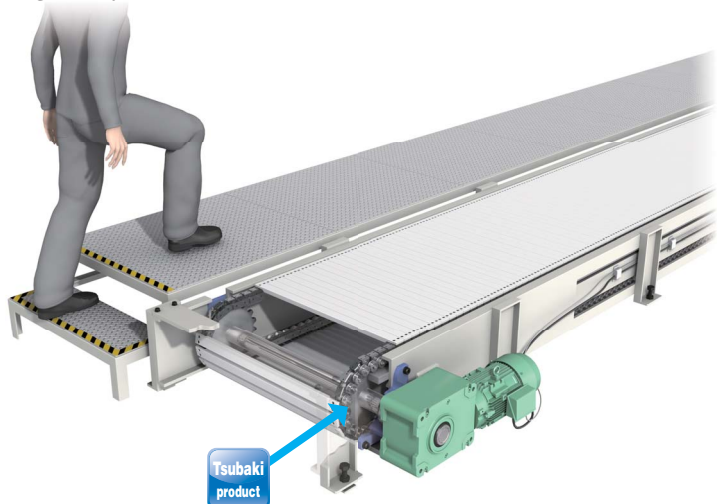



For engine and brake testers Power Cylinder/Cam Clutch

Tsubaki products are also used in engine and brake testers—including Power Cylinders used for pressurizing rollers and positioning front/rear axles, as well as embedded gear reducers for one-way clutches used to drive rollers.

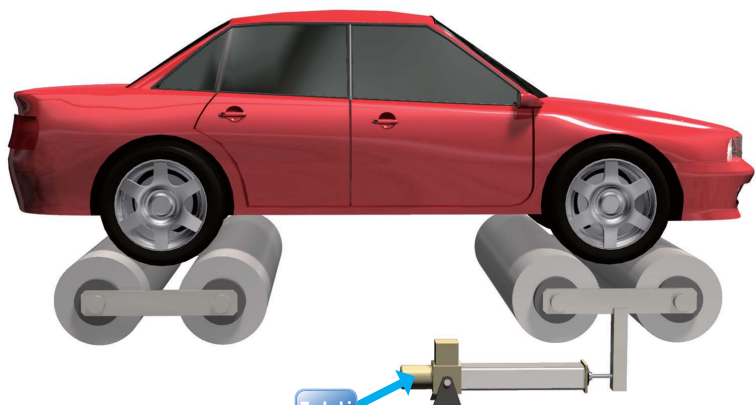

Tsubaki product

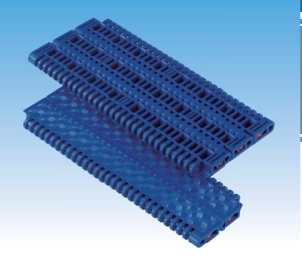
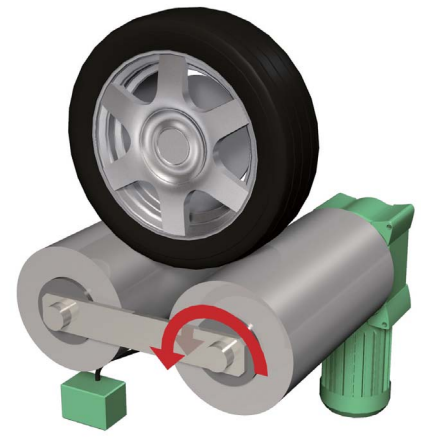

For conveyors Plastic Modular Chain

Our Plastic Modular Chains are employed on the conveyor used in the final inspection process where workers ride along with vehicles during inspections.

The Plastic Modular Chains can be taken apart in pieces to make repairs—further facilitating maintenance.

Low maintenance

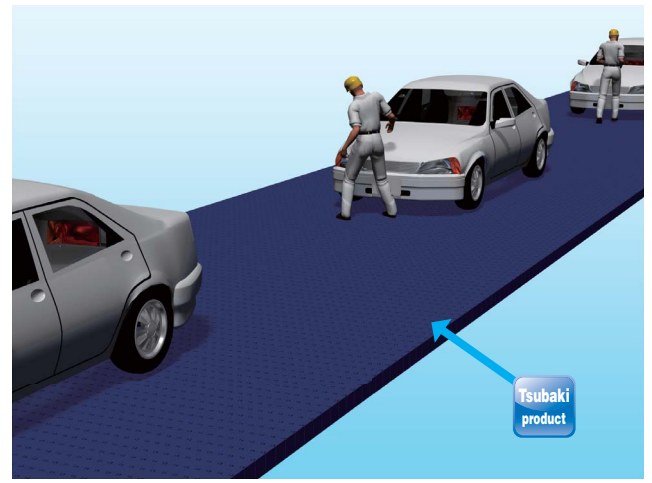

Tsubaki product



For lifting and conveyance equipment Drive Chain

Tsubaki's continually-evolving RS Roller Chains or Super Chains—with their high max. allowable load and compact size—are used for suspended-type drop lifters that are used to lift parts such as body or engine components.

In applications such as this where multiple rows are used, a "combined formation" is possible in which initial chain length differences can be minimized by keeping the relative difference across the overall length as low as possible.

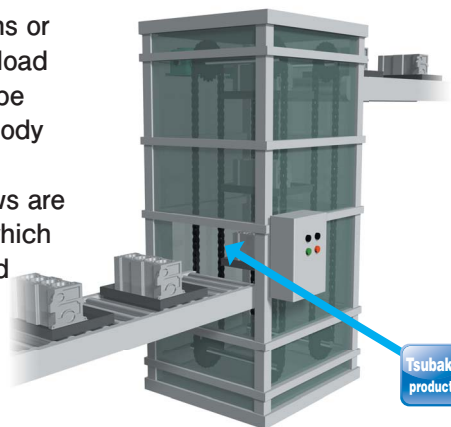

For part conveyance Double Plus Chain/Engineering Plastic Roller Series

A conveyance speed of 2.5X has been realized using our structure in which small diameter and large diameter rollers are used together. The speed of the chains can also be lowered to permit quiet accumulation and installation of snap covers is possible to prevent parts from falling into the conveyor frame. In addition, the wear elongation and service life of the lambda specification have been significantly enhanced for use in environments where lubrication is difficult.

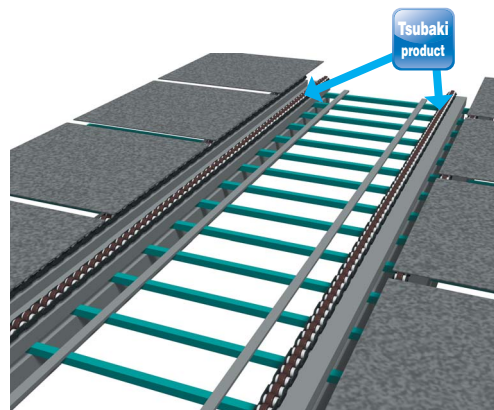

For part conveyance Lube-Free Small Size Conveyor Chain

This Lambda chain—which uses special oil-impregnated bushes—can be used with most small size conveyor chains. The performance of this product has continued to be lauded by customers since first going on sale in 1988.



Basic structure Lambda Chain

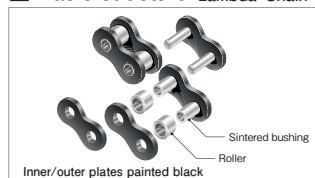

Features of Small Size Lambda Conveyor Chains

- Lube-free, with a long service life A longer service life has been achieved thanks to the effects of our special oil-impregnated bushes.
- Compatibility Compatible with general-purpose, small size conveyor chains.
- Operating temperature range -10°C to $+150^{\circ}\text{C}$ (KF: 230°C)
- Featuring a significantly enhanced wear elongation and service life compared to general-purpose, small size conveyor chains.

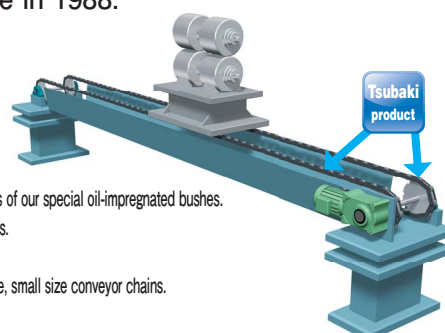

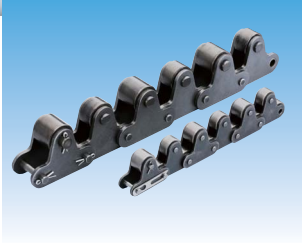

For engine part conveyance Top Roller Chain

Top roller chains are a type of free-flow chain in which free-spinning top rollers are installed on top a stretch of double pitch or RS chain. Roller types can be selected based on the type and location of work being performed, including top rollers with a buffed hard chrome plating to minimize damage to items on the conveyor as well as top roller wear, and lambda rollers designed to improve roller quietness and minimize top roller axle wear while extending service life.

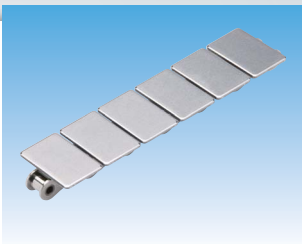
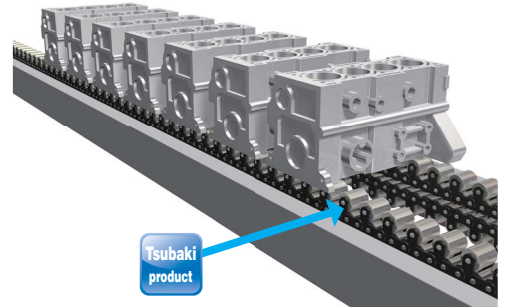

For part conveyance Stainless Steel Top Chain TS Series

This conveyor chain features plates on top of a double pitch chain. It features a tempered plate specification that minimizes plate wear and is commonly used for the conveyance of metal automotive parts. A specification with smaller gaps between plate surfaces designed to prevent items on the conveyor from becoming caught can also be used.

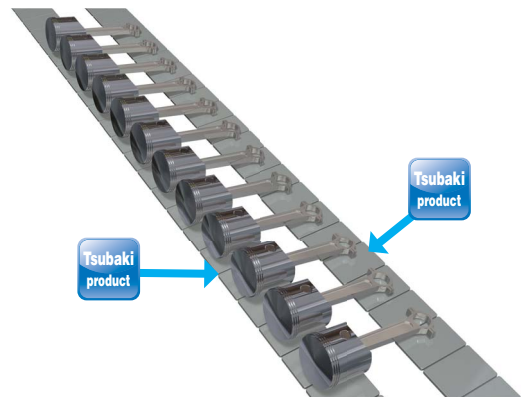

For part conveyance Plastic Top Chain/Accumulation Chain

To minimize part damage during part machining or on the inspection line, conveyors will use plastic chains or accumulation chains in which rollers are embedded into the conveyor surface.





Part Machining and Assembly Shop

For part hanging equipment Zip Chain Actuator®



Our Zip Chain Actuators—capable of being installed in narrow spaces—are used in equipment such as gantry loaders using top hang parts. It can also be used for high-speed lifting, contributing to shortened cycle times.

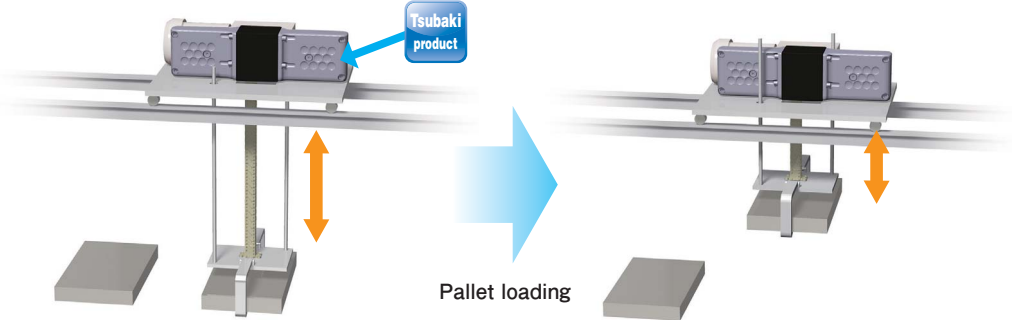

Pallet loading

For lifting part supply pallets Zip Chain Actuator®



Workers perform assembly by having parts lowered to the assembly workbench from the supply conveyor. This equipment uses our Zip Chain Actuator—which is capable of being installed in narrow spaces up to the height of worker waistlines.

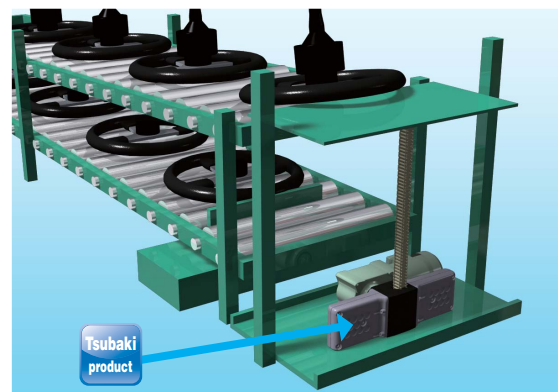

For AGV with lifting equipment Zip Chain Actuator®



In the case of equipment with limited space such as AGVs, Tsubaki's Zip Chain Actuator is used for applications that enable lifting to be performed or for jigs to move. By enabling large-stroke lifting in a limited amount of space, the need for air piping, etc., for electric types can be eliminated.





For part machining equipment Lift Master

Our Lift Master—with its one-side lifting mechanism that helps to downsize equipment—is used on part machining and assembly line equipment designed to lift items to discharge and delivery ports. It can be installed in narrow spaces and facilitates maintenance as a gear reducer can also be installed on top.

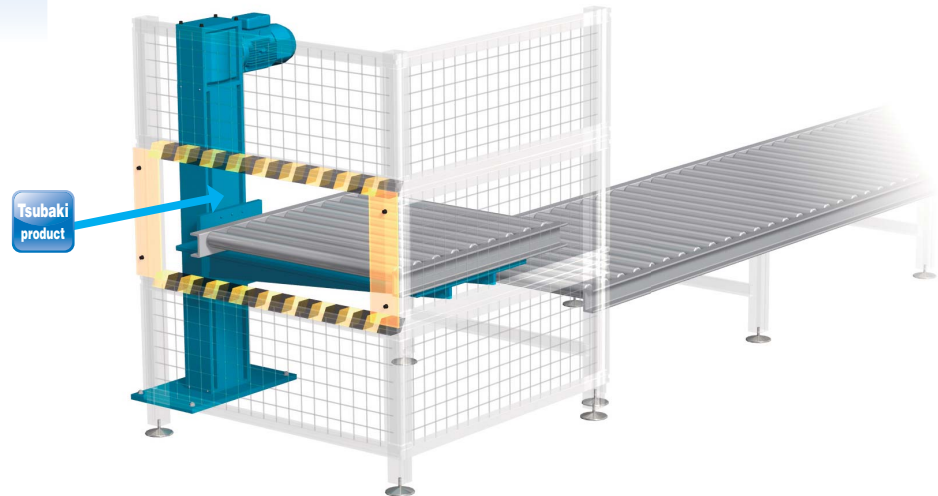

Part assembly equipment Pin Gear Drive Units

Our Pin Gear Drive Units—consisting of a pin wheel and rack, and a gear with a unique tooth profile—is used for part assembly turn tables in which space-saving is a requirement.

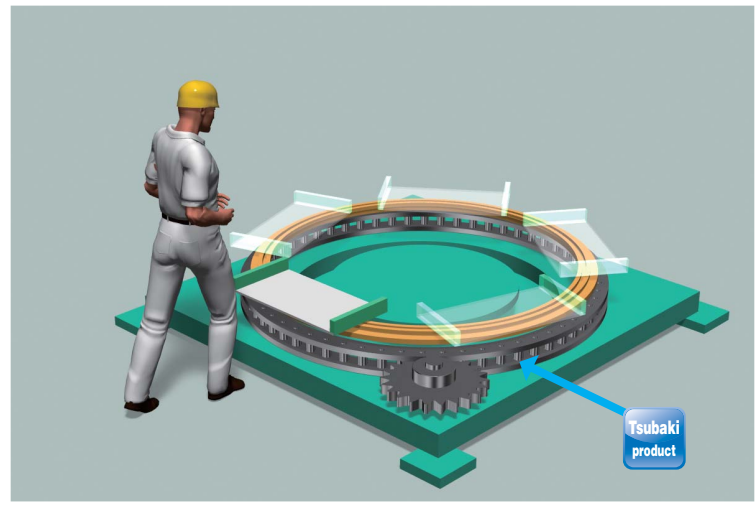

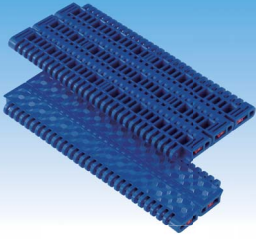

For conveying workers and tool trolleys Plastic Modular Chain

On part machining and assembly lines, worker efficiency is being enhanced by syncing the operation of a conveyor for transporting engine-laden trolleys or hung parts together with a conveyor for carrying workers and tool trolleys. Man conveyors that utilize Tsubaki's Plastic Modular Chain are employed in this synchronized operation. Not only can the desired chain width be used, but shortening of overall installation periods is possible by installing a low-profile man conveyor.

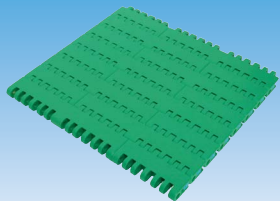
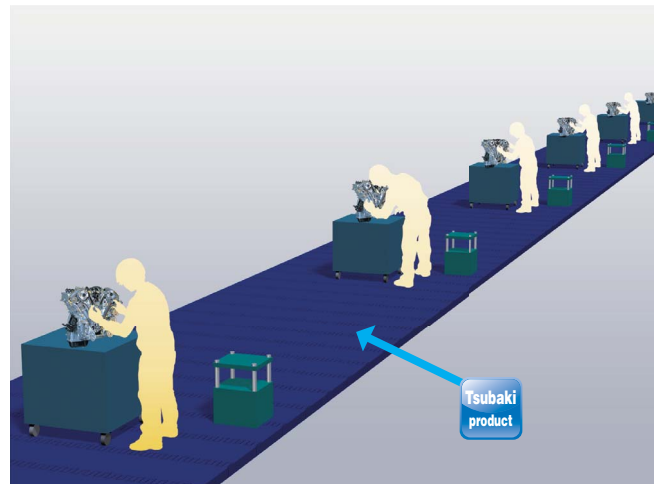

For part conveyance Plastic Modular Chain

Conveyors that utilize Tsubaki's Plastic Modular Chains are employed in equipment used to transport automotive parts loaded onto trolleys both to and from the receiving yard. This low-profile, plug-and-play conveyor can be installed without a pit, enabling equipment to be switched out in a shorter period of time.

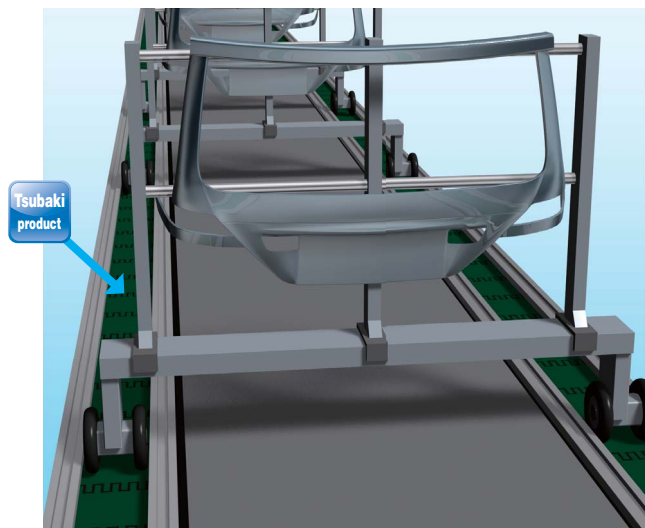

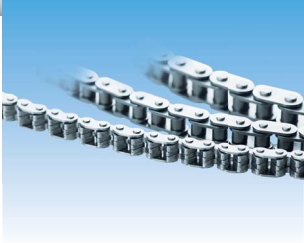

For automobile engines Timing Chain

Tsubaki chains are used for the timing chains used to drive automotive engines. To provide ever higher levels of technical and environmental performance, we here at Tsubaki have continued our efforts in technical innovation while striving to achieve new heights in terms of performance, quality assurance and productivity. Thanks to this, we have received high praise from automotive manufacturers both domestic and international.

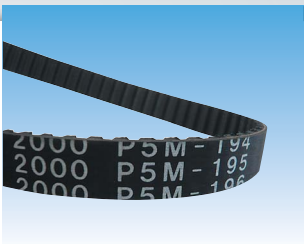
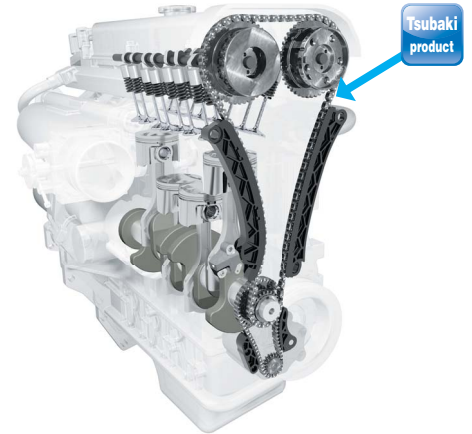

For sliding door systems Timing Belt

Conventionally, the opening and closing of doors has mainly been performed using a wire mechanism—which could become cut or tangled. To resolve this issue, customers turn to Tsubaki Timing Belts. Our popular timing belt features superior bending fatigue resistance and excellent durability. And, because they can be integrated with the belt unit, assembly to the automotive body is facilitated—resulting in their increased use in products.

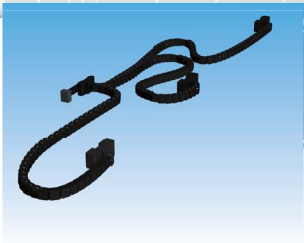
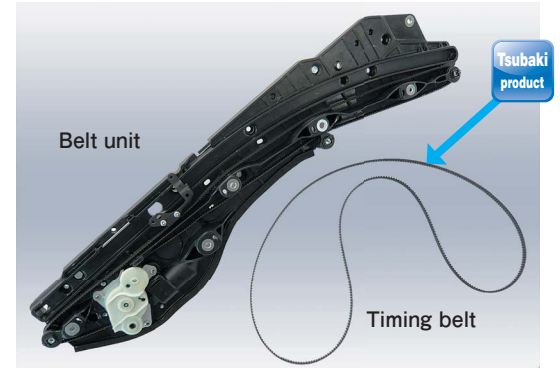

For sliding door systems Cable Carriers

Thanks to the expanding popularity of electric-powered automotive doors, our cable carriers are now used in harness protection devices connected to sliding doors. It helps to maintain the movement of the door along its curved track and was developed to meet the need for special machinery used in applications requiring strong and high levels of durability.

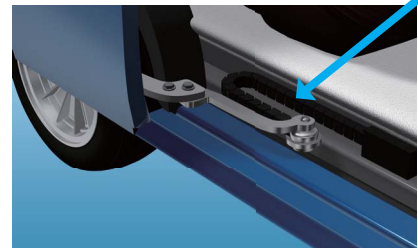
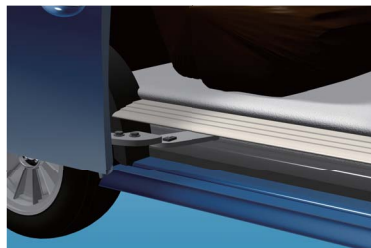
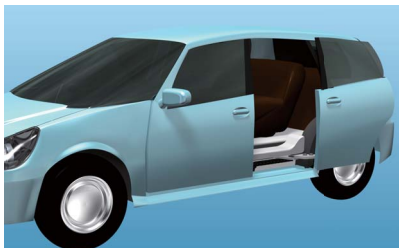

Related Products

Drive Chain

Drive Chain & Sprocket

RS Roller Chain



Evolving chain wear life

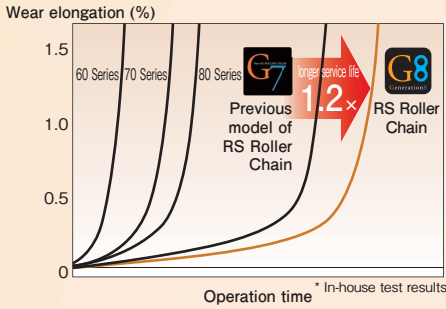

Lube-Free Lambda Drive Chain



These lube-free chains employ our special, oil-impregnated bushes for a long service life. Environmentally friendly NSF H1 certified oil is used for impregnating. This reduces maintenance man-hours and keeps the environment clean.

Corrosion-Resistant Surface Treated Neptune Chain®



This chemical-resistant chain stands up to corrosive or alkaline chemicals thanks to its special surface treatment. It retains its strength and easily replaces steel chains. RoHS compliant.

Small Size Conveyor Chain

This Small Size Conveyor Chain is ideal for the conveyance of parts and pallets. We offer a lineup of chains designed to answer a variety of needs, including free-flow applications in which stopping of items on the conveyor at the desired position can be performed using an external stopper with the chain still running, or for when customers want to install attachments. Please ask us about chains with special shaped attachments.

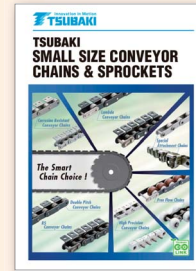

Large Size Conveyor Chain

This large size conveyor chain is ideal for the conveyance of heavy objects. We're here to solve customer problems by utilizing our long track record of success and expansive specification lineup. Our large size conveyor chains—designed to be the ideal chains for any customer application—are marketed as “Smart Conveyor Chain,” with product improvements being rolled out continually.



Cable Carriers

We offer customers a wide lineup of products. This includes our general-purpose TKP standard type, our dust-resistant TKC and TKA closed type models for secure cable protection, as well as our strong TK metal type. We also offer the ROBOTRAX System Cable Carrier for 3D movements.

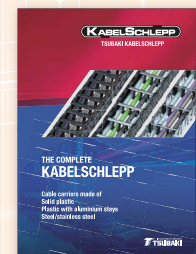

Linear Actuator

Linipower[®] Jack

A jack that combines a ball screw, trapezoidal screw and high-precision worm gear

Power Cylinder

A power cylinder that combines a motor with a ball screw and trapezoidal screw

Lift Master

“Plug-and-play” lifting equipment with an embedded guide mechanism that can be operated on one side

Zip Chain Lifter[®]

Lifting equipment capable of high-speed lifting and high frequency operation thanks to its zip chain design

Zip Chain Actuator[®]

Zip-powered linear actuator that's space-saving

Power Cylinder vs. Hydraulic/pneumatic cylinders

Results of comparative evaluations performed by Shinko Research Co., Ltd.

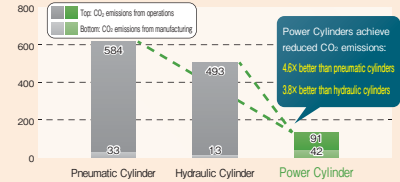

[Comparison conditions]
 ■ Thrust: 3 kN ■ Speed: 200 mm/s ■ Stroke: 500 mm
 ■ 1 cycle/min × 12 hours/day × 250 days/year
 ■ Various drive systems (incl. servomotors, pneumatic and hydraulic units)

For the sake of comparison, LCA evaluations for transportation, disposal and recycling deemed equivalent have been omitted.
 Literature cited: "MILCA ver1.0": Japan Environmental Management Association for Industry (JEMAI), various catalogs, etc.

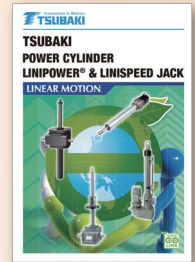

Plastic Modular Chain

A Plastic Modular Chain made up only of plastic parts and commonly used to replace belts or steel chains. Capable of transporting anything from lightweight materials to heavy objects such as automobiles—it securely holds wide conveyance surfaces such as belts to realize stable operation. Anyone can easily perform sectional replacement (maintenance) and handling is easy thanks to its light weight.



Pin Gear Drive Units

Consisting of a pin wheel and rack, and a gear with a unique tooth profile, Pin Gear Drive Units offer limitless design possibilities for rotating and linear drive sections.

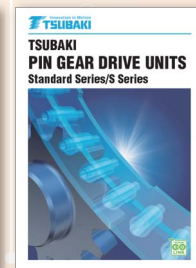



TSUBAKIMOTO CHAIN CO.

Japan	Tsubakimoto Chain Co.	https://tsubakimoto.com/
-------	-----------------------	---

Global Group Companies

AMERICAS

United States	U.S. Tsubaki Power Transmission, LLC	https://www.ustsubaki.com/
Brazil	Tsubaki Brasil Equipamentos Industriais Ltda.	https://tsubaki.ind.br/
Canada	Tsubaki of Canada Limited	https://tsubaki.ca/

EUROPE

Netherlands	Tsubakimoto Europe B.V.	https://tsubaki.eu/
France	Kabelschlepp France S.A.R.L.	https://tsubaki-kabelschlepp.com/fr-fr/
Germany	Tsubaki Deutschland GmbH	https://tsubaki.de/
	Tsubaki Kabelschlepp GmbH	https://tsubaki-kabelschlepp.com/de-de/
Italy	Kabelschlepp Italia S.R.L.	https://tsubaki-kabelschlepp.com/it-it/
Spain	Tsubaki Ibérica Power Transmission S.L.	https://tsubaki.es/
United Kingdom	Tsubakimoto UK Ltd.	https://tsubaki.eu/
Slovakia	Kabelschlepp-Systemtechnik, spol. s.r.o.	https://tsubaki-kabelschlepp.com/sk-sk/
Poland	Kabelschlepp Sp. z o.o.	https://kabelschlepp.pl/

INDIAN OCEAN RIM

Singapore	Tsubakimoto Singapore Pte. Ltd.	https://tsubaki.sg/
Australia	Tsubaki Australia Pty. Limited	https://tsubaki.com.au/
India	Tsubaki India Power Transmission Private Limited	https://en.tsubaki.in/
Indonesia	PT. Tsubaki Indonesia Trading	https://tsubaki.id/
Malaysia	Tsubaki Power Transmission (Malaysia) Sdn. Bhd.	https://en.tsubaki.my/
New Zealand	Tsubaki Australia Pty. Limited - New Zealand Branch	https://tsubaki.com.au/
Philippines	Tsubakimoto Philippines Corporation	https://en.tsubaki.ph/
Thailand	Tsubakimoto (Thailand) Co., Ltd.	https://tsubaki.co.th/
Vietnam	Tsubakimoto Vietnam Co., Ltd.	https://tsubaki.net.vn/

EAST ASIA

Republic of Korea	Tsubakimoto Korea Co., Ltd.	https://tsubakimoto-tck.co.kr/
Taiwan	Taiwan Tsubakimoto Trading Co., Ltd.	https://tsubakimoto.tw/

CHINA

China	Tsubakimoto Chain (Shanghai) Co., Ltd.	https://www.tsubaki-sh.cn/
-------	--	---
