

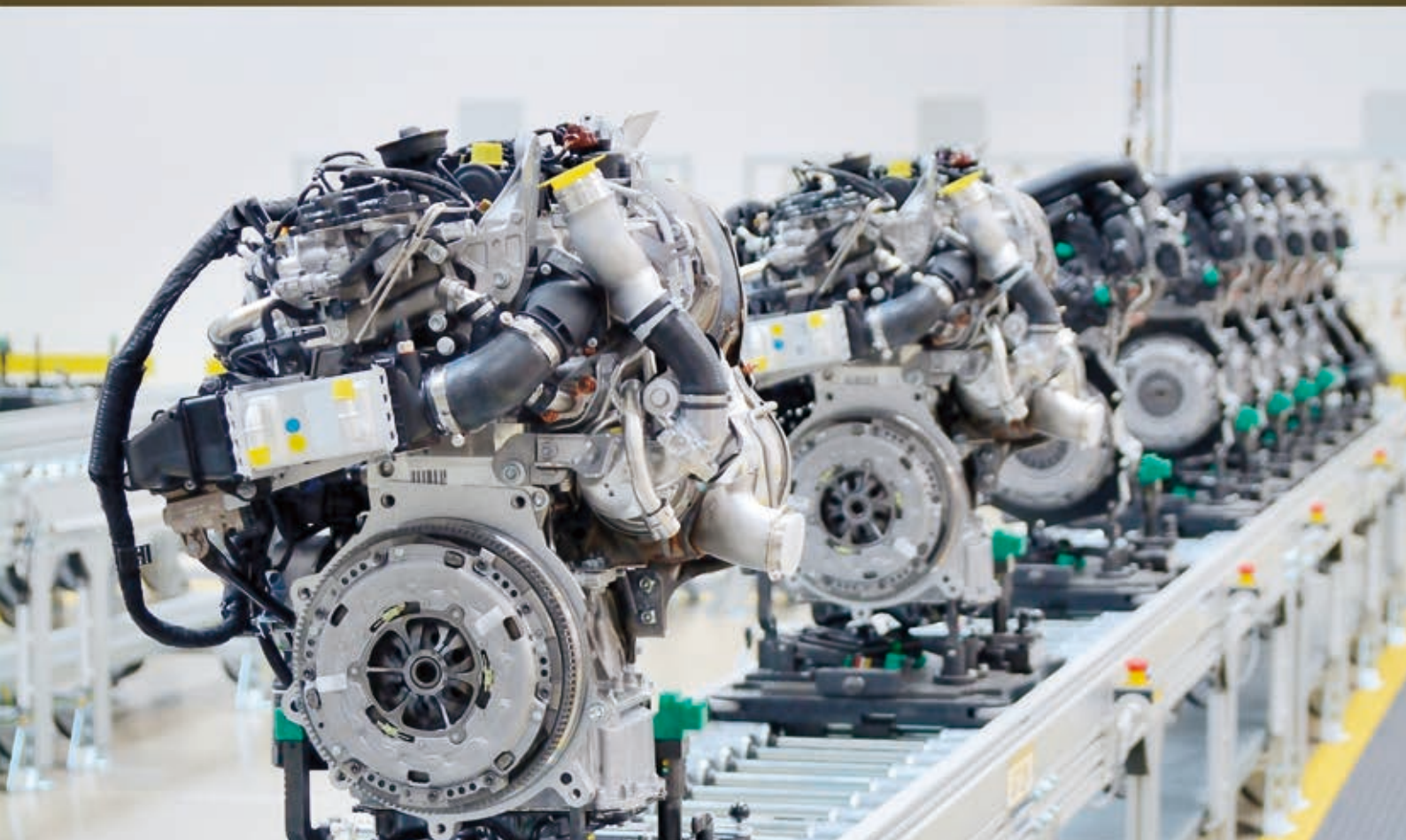

# Power and Performance

## for the Automotive Industry Vol.II





# You'll find many Tsubaki products being

There are many processes involved in making a motor vehicle. You'll find Tsubaki products in all of these processes, from conveying vehicle bodies from the stockyard, components from the formation presses, and assembled bodies from the welding process to the coating process, to the mounting and assembly processes for the interior, engine, transmission, and other components, and finally to engine output, brakes, and shower testing lines

1

## Press Section

Cutting, casting, forging, sheet metal presses, plastic molding, etc

5

## Inspection Section

Engine output, brakes, shower tester, visual inspection

4

## Assembly Section

Mounting of interior components (engine, suspension, transmission, dashboard, seats, electrical components) and exterior components (tires, fenders, side view mirrors, etc.)



Liftmaster



Small Size Lube-free Conveyor Chain

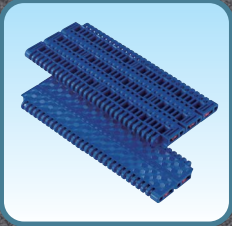

Plastic Modular Chain



# used in automotive manufacturing

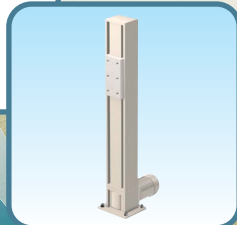
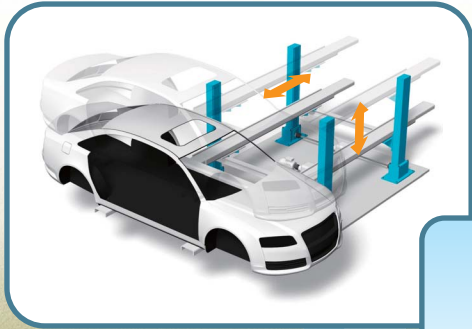

Liftmaster



ROBOTRAX System plastic cable carrier



Lube-free Series Bearing Roller Conveyor Chain

## 2

### Body Welding Section

Welding and assembly of roofs and body panels

## 3

### Coating Section

Coating of bodies, doors, and other components

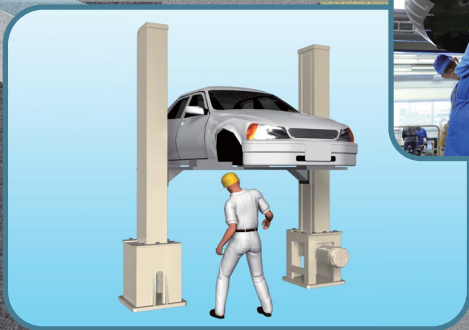

Strong (relatively high-strength product)



Compact



Simple installation



Low maintenance



# Body Welding Section



## ROBOTRAX System Cable Carrier (Body assembly equipment)



Scan for video

The arms on robots that weld the bodies use ROBOTRAX System cable carriers that can move three dimensionally. ROBOTRAX System uses a special plastic to give it superior cable/hose protection and endurance, and its steel wire core gives it a high allowable load. Cables/hoses can be simply pushed into its open structure, making maintenance work easy

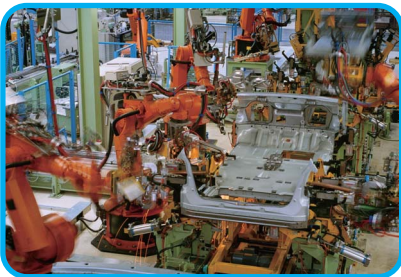
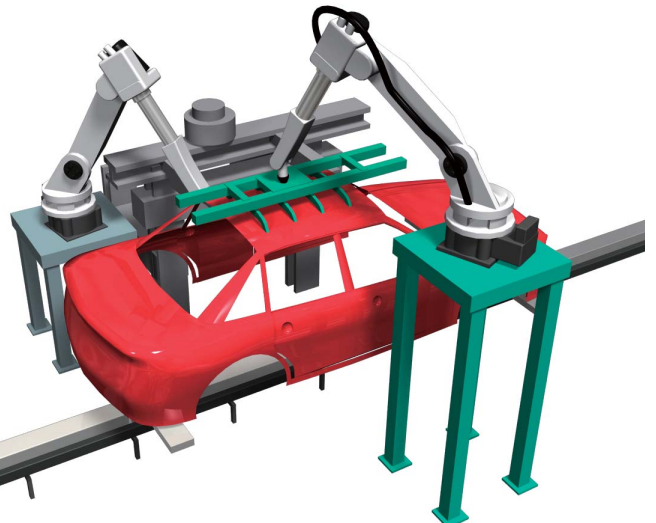

## Liftmaster (Body and part assembly equipment)

Liftmasters are low-floor, compact devices used to lift and lower incoming/outgoing work on welding and assembly lines for body frames, doors, and other parts.

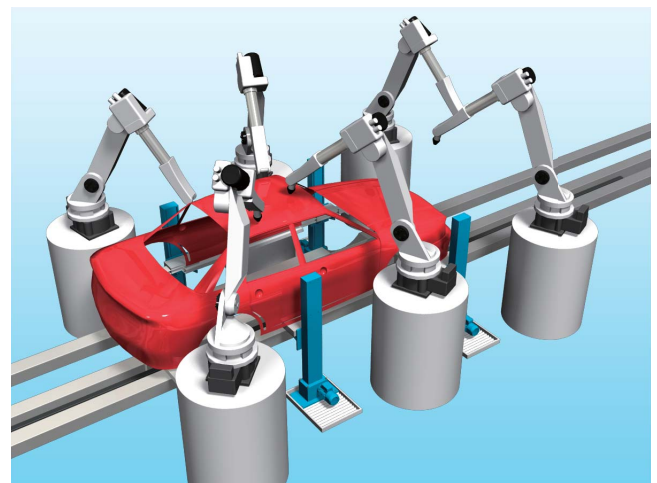



## Liftmaster (Body assembly equipment)



Scan for video

Liftmasters, which can withstand lateral loads and have a long service life, are used in equipment that loads assembled bodies onto carts to be transferred to the next process.

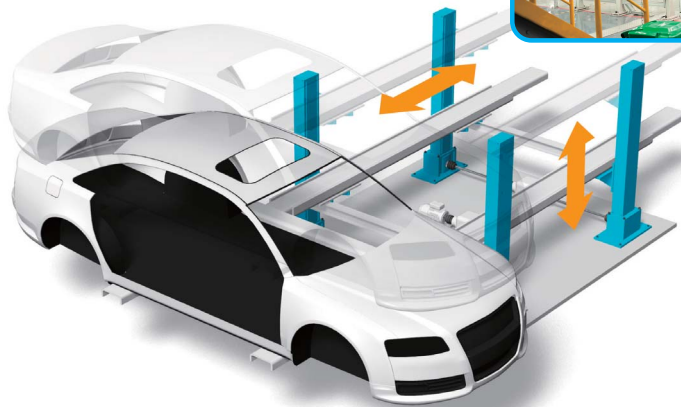

## Double Plus Conveyor Chain (Pallet conveyance)



Uses Double Plus Conveyor Chain, which offers stable running and accumulation capabilities on the low body return conveyor between the rail and the cart.





# Assembly Section

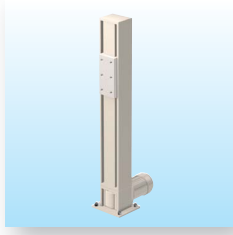

## Liftmaster (Body assembly equipment)



Scan for video

Liftmasters are positioned on either side lift the body, ensuring proper workability and minimizing the need to change equipment with each production model.

**High Strength Series** —  
Tsubaki offers a High Strength Series with a stronger supporting column for when vibration during lifting and sag when stopped are problems. Contact a Tsubaki representative for more information.

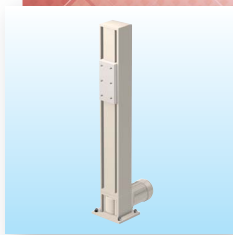
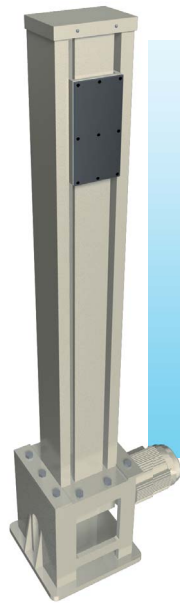

## Liftmaster (Part lifters)

Uses compact, low-floored Liftmasters on equipment that lifts incoming/outgoing work on lines where body frames, doors, and other parts are welded and assembled.

**Low Floor Specifications** —  
Tsubaki offers low-bodied specifications for situations where space limitations prevent Liftmasters from being installed. Contact a Tsubaki representative for more information.

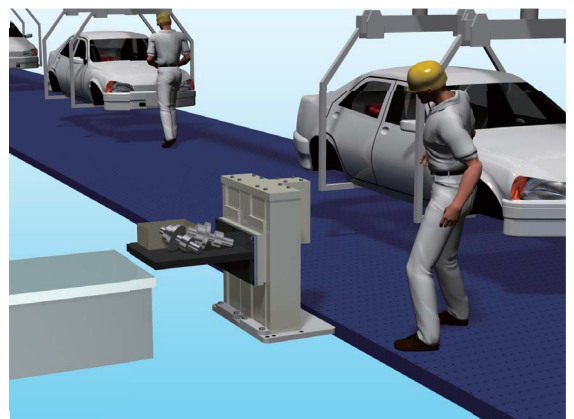
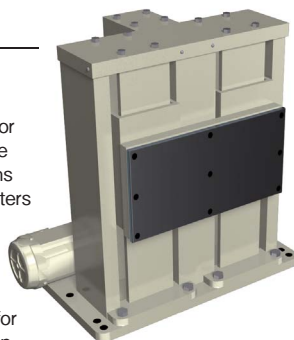

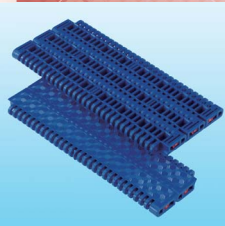

## Modular Chain for Man Conveyors (Body assembly equipment)



Scan for video

Clean, quiet, lube-free plastic modular chains are used on low conveyors that workers ride on together with parts to be installed. BTH Series has a high maximum allowable load and a slip-resistant surface structure, and uses a special easy to connect/disconnect slide plug system.

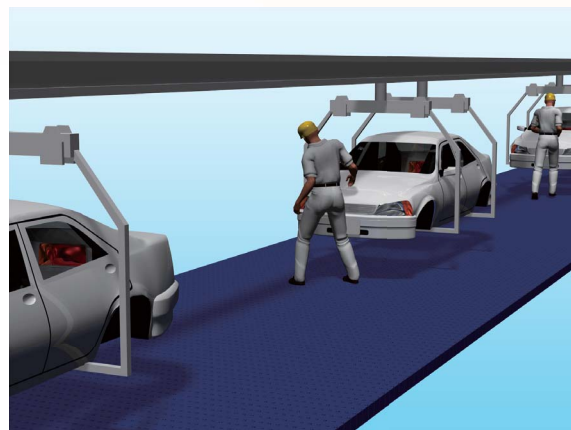
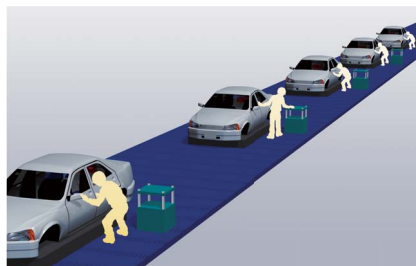

## Liftmaster (Tire assembly equipment)

There is equipment that unstacks and divides the four stacked tires that are conveyed to the assembly line. This equipment uses a Liftmaster on either side.

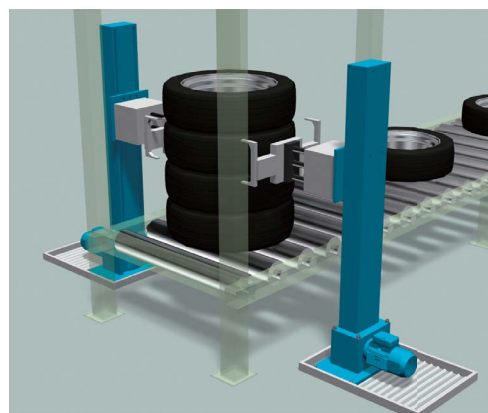

## Liftmaster (Part stocker)

Parts to be installed are managed on pallets for each car body. Liftmasters are used on the lifters that store pallets waiting for their turn to be assembled on simple stockers.

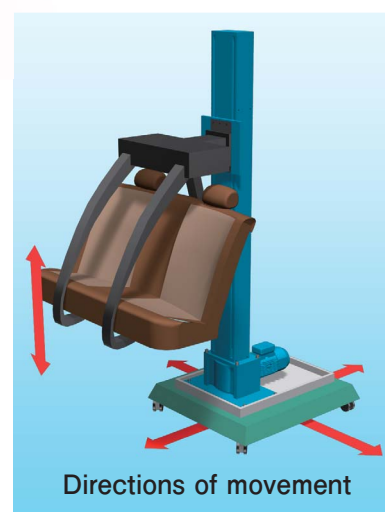

Directions of movement



# Part Assembly Section

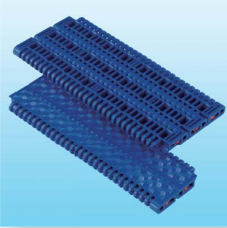

## Modular Chain (Part assembly equipment)



Plastic modular chains are used on conveyors on part processing and assembly lines where workers ride together with the parts and car bodies to be assembled.

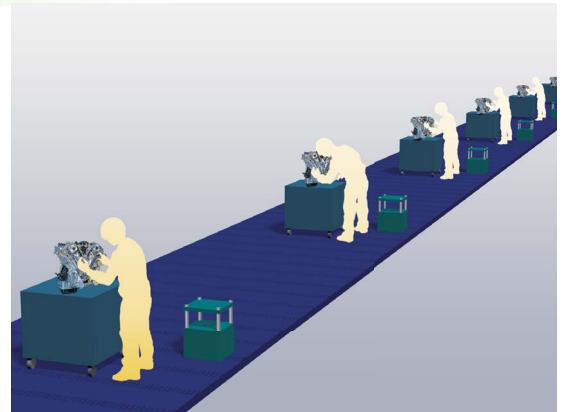

## Small Size Conveyor Chain (Interior/exterior part assembly equipment)



Pallets with parts are conveyed on the seat assembly line to the assembly area. After assembly, friction conveyors quickly carry them away. Individual Liftmasters are used on equipment to lift the pallets, which are then conveyed by Free Flow Chains that can accumulate assembled parts on assembly lines. Tsubaki hypoid reducers are used on the friction conveyors to carry the assembled products downstream.



Scan for video



Scan for video

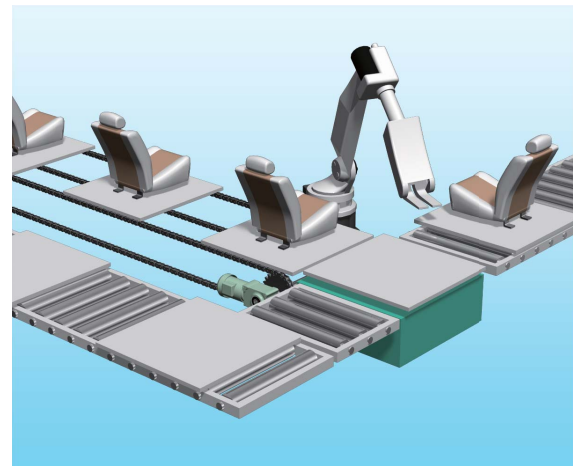
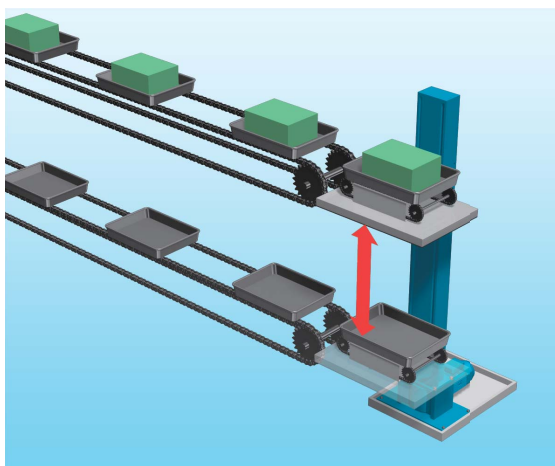





## ZIP CHAIN ACTUATOR (Part loaders)



Parts are lifted from the supply conveyor to the work bench, where they are assembled by workers. Zip Chain Actuators can be installed in narrow spaces to lift the parts to worker hip-level.

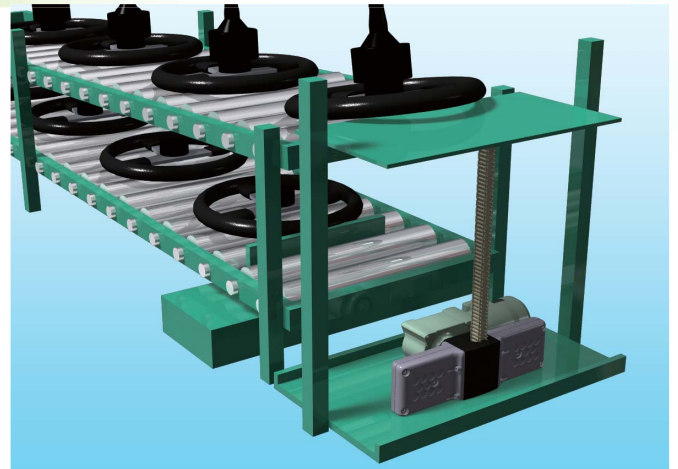

## Liftmaster (Part processing and assembly equipment)



Compact Liftmasters, which offer stand-alone lifting, are used in conveyor feed/output areas to lift parts on processing and assembly lines.

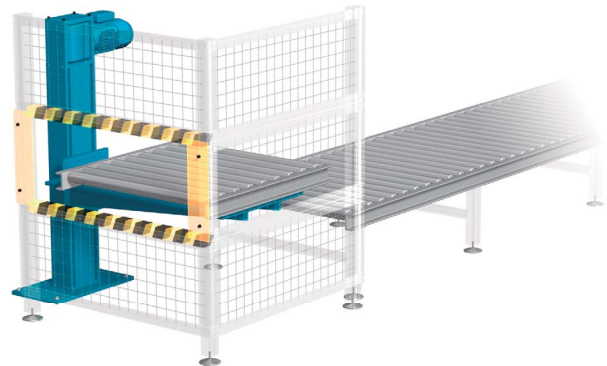

## Pin Gear Drive Unit (Part assembly equipment)



Part assembly needed to be more compact, so the customer used a turntable to assemble and attach parts. The turntable uses a Pin Gear Drive Unit that combines a pin-type wheel rack and a special gear.

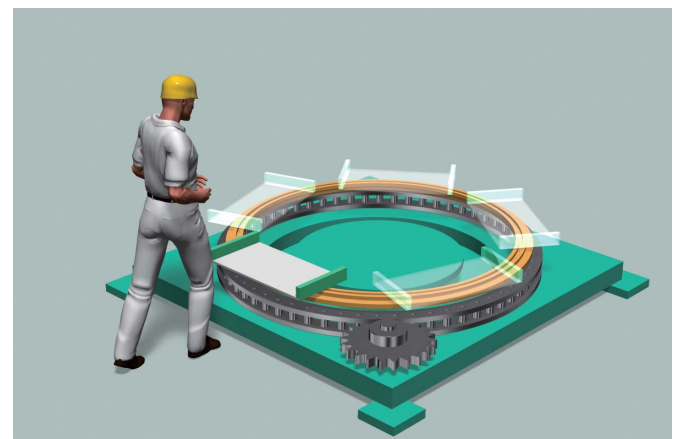



# Related Products

## Lube-free Small Size Conveyor Chain

Basic Lambda Chain construction

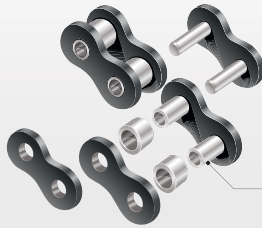

Lubricant  
(Uses NSF-H1 food grade lubricant)

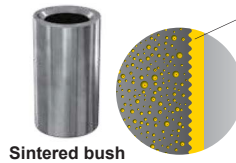

Tsubaki lube-free Lambda Chain has gained an outstanding reputation in a variety of industries and applications. It is capable of meeting a wide range of customer needs for long life in a lubrication-free environment, resulting in a reduction in overall long-term costs.



## Plastic Modular Chain

### Features

1. Enables floor-height conveyors without the need for pits.
2. Provides worker-friendly stable footing.
3. Chain sections can be easily replaced with just a screwdriver.
4. High durability and long life (compared to belt conveyors).

Many conveyors using plastic modular chain are used in automotive plants to convey cars, parts carts, and workers.

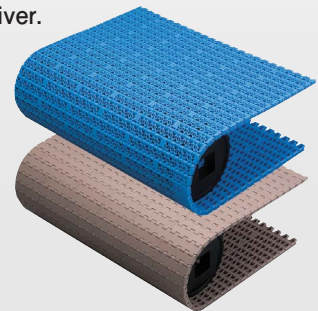

## ROBOTRAX System CABLEVEYOR®

Provides cable protection and guidance in 3D swiveling and rotational movement.

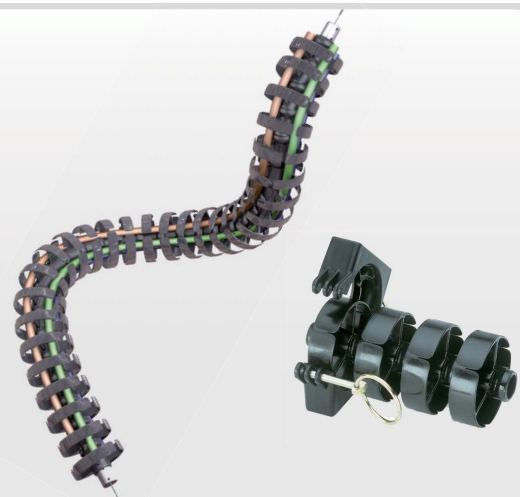





The Tsubaki Eco Link logo is used only on products that satisfy the standards for environmental friendliness set by the Tsubaki Group.

## Liftmaster

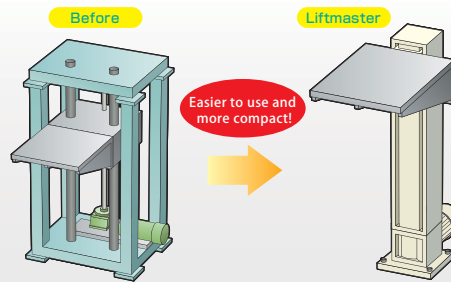

A compact electric cylinder with screws and guides built into the frame. The embedded guide structure is strong and allows for stand-alone lifting, and the unit's simple installation can reduce labor time.



Scan for video

## Zip Chain Actuator

### 1. Compact

Can be installed in tighter spaces than other linear actuators. (Superior space savings)

- ZCA025M030-□□
- Hydraulic cylinder
- Pneumatic cylinder

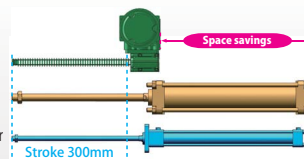

### 2. High speed

Much quicker operation compared to screw jacks and hydraulic/pneumatic cylinders. (Max speed: 1000 mm/sec)

### 3. Eco-friendly

Comparison of annual CO2 emissions  
 ZCA:pneumatic cylinder:hydraulic cylinder: 1:3:5  
 Comparison of annual power consumption  
 ZCA:pneumatic cylinder:hydraulic cylinder: 1:5:14

An actuator that uses a chain to provide direct thrust and enable high speed operation. Zip Chain Actuators can be installed in tight spaces, and have a high degree of installation freedom.



\*ZIP CHAIN ACTUATOR is a trademark of Tsubakimoto Chain Co.

## Pin Gear Drive Unit

Combines a pin-type wheel rack and a special gear for a high degree of design freedom in rotating and linear drives.

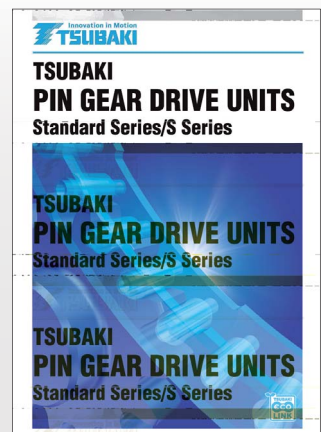





## TSUBAKIMOTO CHAIN CO.

Japan Tsubakimoto Chain Co. <https://tsubakimoto.com/>

### Global Group Companies

#### AMERICAS

United States U.S. Tsubaki Power Transmission, LLC <https://www.ustsubaki.com/>  
Brazil Tsubaki Brasil Equipamentos Industriais Ltda. <https://tsubaki.ind.br/>  
Canada Tsubaki of Canada Limited <https://tsubaki.ca/>

#### EUROPE

Netherlands Tsubakimoto Europe B.V. <https://tsubaki.eu/>  
France Kabelschlepp France S.A.R.L. <https://tsubaki-kabelschlepp.com/fr-fr/>  
Germany Tsubaki Deutschland GmbH <https://tsubaki.de/>  
Tsubaki Kabelschlepp GmbH <https://tsubaki-kabelschlepp.com/de-de/>  
Italy Kabelschlepp Italia S.R.L. <https://tsubaki-kabelschlepp.com/it-it/>  
Spain Tsubaki Ibérica Power Transmission S.L. <https://tsubaki.es/>  
United Kingdom Tsubakimoto UK Ltd. <https://tsubaki.eu/>  
Slovakia Kabelschlepp-Systemtechnik, spol. s.r.o. <https://tsubaki-kabelschlepp.com/sk-sk/>  
Poland Kabelschlepp Sp. z o.o. <https://kabelschlepp.pl/>

#### INDIAN OCEAN RIM

Singapore Tsubakimoto Singapore Pte. Ltd. <https://tsubaki.sg/>  
Australia Tsubaki Australia Pty. Limited <https://tsubaki.com.au/>  
India Tsubaki India Power Transmission Private Limited <https://en.tsubaki.in/>  
Indonesia PT. Tsubaki Indonesia Trading <https://tsubaki.id/>  
Malaysia Tsubaki Power Transmission (Malaysia) Sdn. Bhd. <https://en.tsubaki.my/>  
New Zealand Tsubaki Australia Pty. Limited - New Zealand Branch <https://tsubaki.com.au/>  
Philippines Tsubakimoto Philippines Corporation <https://en.tsubaki.ph/>  
Thailand Tsubakimoto (Thailand) Co., Ltd. <https://tsubaki.co.th/>  
Vietnam Tsubakimoto Vietnam Co., Ltd. <https://tsubaki.net.vn/>

#### EAST ASIA

Republic of Korea Tsubakimoto Korea Co., Ltd. <https://tsubakimoto-tck.co.kr/>  
Taiwan Taiwan Tsubakimoto Trading Co., Ltd. <https://tsubakimoto.tw/>

#### CHINA

China Tsubakimoto Chain (Shanghai) Co., Ltd. <https://www.tsubaki-sh.cn/>



The Tsubaki Eco Link logo is used only on products that satisfy the standards for environmental friendliness set by the Tsubaki Group.